

MB890

Intel Pentium® M
Mini-ITX Motherboard

USER'S MANUAL

Version 1.0

Acknowledgments

Award is a registered trademark of Award Software International, Inc.

PS/2 is a trademark of International Business Machines Corporation.

Intel and Pentium M are registered trademarks of Intel Corporation.

Microsoft Windows is a registered trademark of Microsoft Corporation.

Winbond is a registered trademark of Winbond Electronics Corporation.

All other product names or trademarks are properties of their respective owners.

Table of Contents

Introduction.....	1
Product Description	1
Checklist	2
MB890 Specifications.....	3
Board Dimensions.....	4
Installations.....	5
Installing the CPU	6
Installing the Memory	7
Setting the Jumpers.....	8
Connectors on MB890.....	13
BIOS Setup.....	25
Drivers Installation	49
Intel Chipset Software Intallation Utility	50
VGA Drivers Installation	52
AC97 Codec Audio Driver Installation.....	53
Intel PRO LAN Drivers Installation	54
Appendix.....	55
A. I/O Port Address Map.....	55
B. Interrupt Request Lines (IRQ)	56
C. Watchdog Timer Configuration	57
D. Digital I/O Sample Code	61

This page is intentionally left blank.

Introduction

Product Description

The MB890 Mini ITX board incorporates the Intel® advanced 855GME Chipset that contains two core components: the Memory Controller Hub (GMCH) and ICH4. The GMCH integrates a 400MHz Pentium® M processor front side bus controller, integrated graphics controller hub, integrated LVDS interface, two digital video out ports multiplexed with an AGP 4x controller, a 200/266/333MHz DDR-SDRAM controller, and a high-speed accelerated hub architecture interface for communication with the ICH4.

The ICH4 integrates an Ultra ATA 100/66/33 controller, USB host controller that supports the USB 1.1 and USB 2.0 specification, LPC interface, FWH Flash BIOS interface controller, AC'97 digital controller and a hub interface for communication with the GMCH.

The Pentium M processor is a higher performance, lower power processor with several microarchitectural enhancements over existing Intel low-power processors. Some key features of the Pentium M processor microarchitecture include dynamic execution, data pre-fetch logic, 400MHz source-synchronous Front Side Bus (FSB), on-die 1 Mbyte second level cache (on-die 512Kbyte second level cache on Celeron M processor) with advanced transfer cache architecture, streaming SIMD extensions 2 (SSE2), and Enhanced Intel SpeedStep technology.

The super I/O W83627THF onboard integrates the following major peripheral functions in a chip: the disk driver adapter (FDC), serial port (UART), parallel port (SPP/EPP/ECP), keyboard controller (KBC), SIR, game port, MIDI port, hardware monitor, ACPI and On Now Wake-up features.

MB890 supports both DVI and optional TV-OUT with the use of the Chrontel CH7009 (default) or support DVI only with the use of the Chrontel CH7301. The TV-Out processor performs non-interlace to interlace conversion with scaling and flicker filters, and encodes the data into any of the NTSC or PAL video standards.

The MB890 Mini-ITX motherboard supports CRT VGA interface as well. Intel 82541GI supports Gigabit Ethernet functionality. The board also has AC97 5.1CH audio, 2 COM ports, UDMA 100, 6 USB ports, watchdog timer and a PCI slot for expandability. Dimensions of the board are 170mm x 170mm.

Note: MB890 uses 852GM and MB890F uses 855GME chipset.

Checklist

Your MB890 package should include the items listed below.

- The MB890 Pentium® M Mini-ITX motherboard
- This User's Manual
- 1 CD containing chipset drivers and flash memory utility
- Cable kit (IDE, Power, Audio, VGA CRT)

MB890 Specifications

CPU Type	Micro-FCPGA Intel® Pentium® M processor
System Speed	Up to 1.8GHz
CPU Frequency	400 MHz
Green /APM	APM1.2
CPU Socket	Socket 479
Chipset	Intel® 855GME / 852GM chipset
BIOS	Award BIOS; support ACPI function
Cache	1MB Level 2 (CPU integrated)
VGA	Intel® 82855GME built-in Intel® extreme Graphics 2 64MB shared with system
LVDS	Intel® 82855GME built-in, single- or dual-channel panel support up to UXGA panel resolution. Resolution max. up to 1600x1200, 24bit
DVI	Chrontel CH7009 DVI /TV out or CH7301 DVI only
LAN	ICH4 integrated LAN controller (10/100Mb) + PHY 82562EZ or Intel® 82541GI Gigabit LAN controller
1394 (option)	TSB43LV22 1394 controller
Memory Type	One DDR DIMM socket, supports up to 1GB DDR 200/266/333 SDRAM
LPC I/O	Winbond W83627THF: Parallel x1, COM1 (RS-232), COM2 (RS-232/422/485), FDC 1.44MB (Slim), IrDA, Hardware monitoring
RTC/CMOS	Intel® ICH4 built-in RTC with onboard lithium battery
Keyboard/Mouse	PS/2 Keyboard/Mouse connectors
IDE Interface	Two channels; supports Ultra DMA 33/66/100
Sound	ICH4 built-in Sound controller + AC97 Codec ALC 650, 5.1 channel (Line-out, Line-in & Mic.)
USB	6 ports, USB 2.0
Watchdog Timer	256 segments (0, 1, 2,... 255 sec/min)
Edge Connectors	DVI, RJ45 + USBx2, Parallel Port, COM 1 & COM 2, PS/2 KB/MS, optional 1394
On Board Pin-Header / Connectors	40 pins box-header x 1 (IDE1), 44 pins box-header x 1 (IDE2), 8 pins pin-header x 3 for USB 2/3; USB 4/5 & 1394 (option), Audio, TV-out (option), IrDA, 2x LVDS, CF socket (option), Slim FDD, 20-pin function connector.
Power Connector	Input: One DC power jack input (+19V or +12V) and one internal 4-pins power connector Output: One 4-pins power connector for CD-ROM and one 4-pins power connector for FDD
Expansion Slots	PCI slot x1 (supports 2 Bus master), optional Mini-PCI
Form Factor	Mini-ITX
Dimensions	170mm x 170mm

Board Dimensions

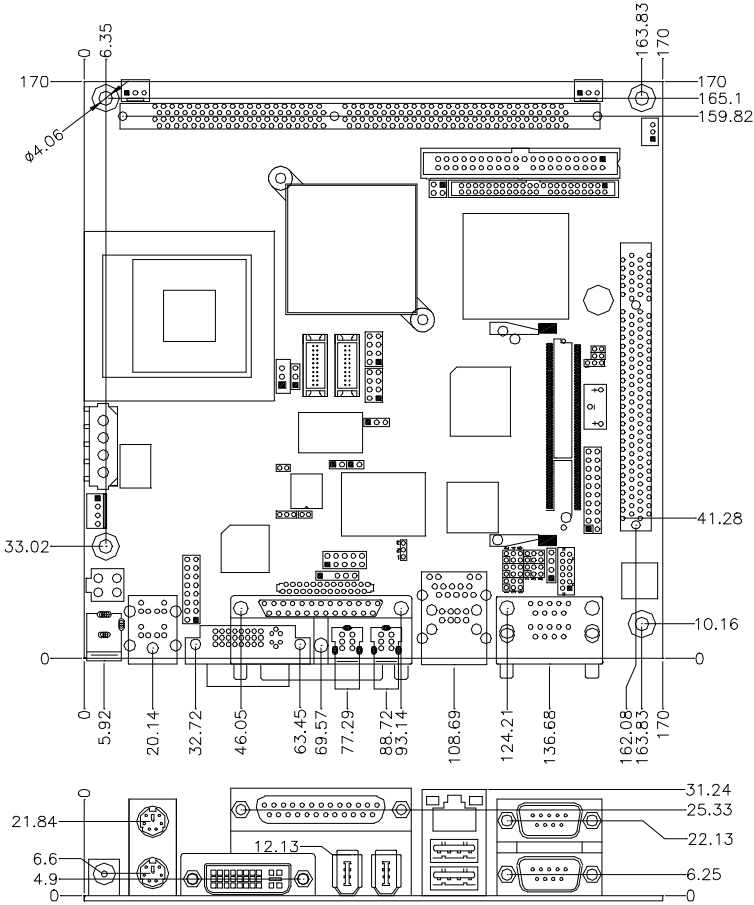

Installations

This section provides information on how to use the jumpers and connectors on the MB890 in order to set up a workable system. The topics covered are:

Installing the CPU	6
Installing the Memory	7
Setting the Jumpers.....	8
Connectors on MB890.....	13

Installing the CPU

The MB890 board supports a Socket 479 processor socket for Intel® Pentium® M or Celeron® M processors.

The processor socket comes with a screw to secure the processor. As shown in the left picture below, loosen the screw first before inserting the processor. Place the processor into the socket by making sure the notch on the corner of the CPU corresponds with the notch on the inside of the socket. Once the processor has slide into the socket, fasten the screw. Refer to the figures below.

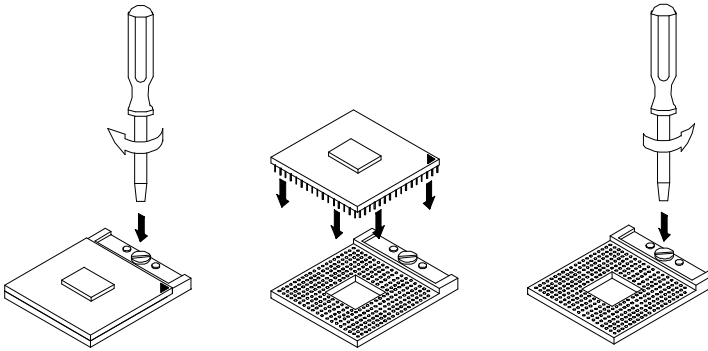

NOTE: *Ensure that the CPU heat sink and the CPU top surface are in total contact to avoid CPU overheating problem that would cause your system to hang or be unstable.*

Installing the Memory

The MB890 board supports one DDR memory sockets for a maximum total memory of 1GB in DDR memory type. The memory module capacities supported are 128MB, 256MB, 512MB and 1GB. The following table lists the supported DDR DIMM configurations. Intel® 855GME supports configurations defined in the JEDEC DDR DIMM specification only. Non-JEDEC standard DIMMs such as double-sided x16 DDR SDRAM DIMMs are not supported.

Installing and Removing Memory Modules

To install the DDR modules, locate the memory slot on the board and perform the following steps:

1. Hold the DDR module so that the key of the DDR module align with those on the memory slot.
2. Gently push the DDR module in an upright position until the clips of the slot close to hold the DDR module in place when the DDR module touches the bottom of the slot.
3. To remove the DDR module, press the clips with both hands.

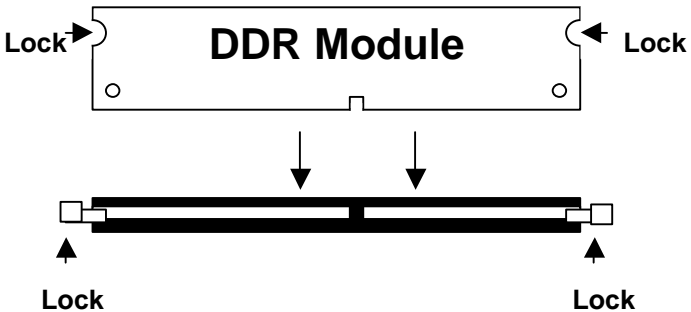



Setting the Jumpers



Jumpers are used on MB890 to select various settings and features according to your needs and applications. Contact your supplier if you have doubts about the best configuration for your needs. The following lists the connectors on MB890 and their respective functions.

Jumper Locations on MB890	9
JP1: CPU Host Clock	10
JP2: Power Mode Setting	10
JP3: LVDS Power Setting	10
JP4: 1394 Controller EEPROM Write Protect	10
JP6, JP7, JP8: RS232/422/485 (COM2) Selection	11
JP9: COM2 RS232 Pin9 Setting.....	11
JP10: COM1 RS232 Pin9 Setting.....	11
JP11: Clear CMOS Contents.....	12
JP13: Compact Flash Mode Setting.....	12
J13: Intel® 82541GI Gigabit LAN Enable/Disable.....	12



JP1: CPU Host Clock

SEL-0	SEL_1 (JP1)	SEL_2	Host Clock
1	 Short	0	100MHz (default)
1	 Open	0	133MHz



JP2: Power Mode Setting

JP2	Power Mode
 1 2 3	Simulate ATX Power Mode (default)
 1 2 3	AT Power Mode

JP3: LVDS Power Setting

JP3	LVDS Power
 1 2 3	+3.3V (default)
 1 2 3	+5V

JP4: 1394 Controller EEPROM Write Protect

JP4	Function
 Open	Write Disable
 Short	Write Enabled

JP6, JP7, JP8: RS232/422/485 (COM2) Selection

COM1 is fixed for RS-232 use only.

COM2 is selectable for RS232, RS-422 and RS-485.

The following table describes the jumper settings for COM2 selection.

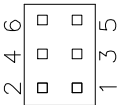

COM2 Function	RS-232	RS-422	RS-485
Jumper Setting (pin closed)	JP6: 3-5 & 4-6	JP6: 1-3 & 2-4	JP6: 1-3 & 2-4
	JP7: 3-5 & 4-6	JP7: 1-3 & 2-4	JP7: 1-3 & 2-4
	JP8: 1-2	JP8: 3-4	JP8: 5-6

JP9: COM2 RS232 Pin9 Setting

Pin #	Signal Name	JP9	Signal Name	Pin #
1	RI		+12V	2
3	RI (Default)		RI (Default)	4
5	RI		+5V	6

COM2 Settings: Pin 1-2 short = +12V, Pin 5-6 short = +5V, Pin 3-4 RI Signal (default)



JP10: COM1 RS232 Pin9 Setting

Pin #	Signal Name	JP10	Signal Name	Pin #
1	RI		+12V	2
3	RI (Default)		RI (Default)	4
5	RI		+5V	6



COM1 Settings: Pin 1-2 short = +12V, Pin 5-6 short = +5V, Pin 3-4 RI Signal

JP11: Clear CMOS Contents



Use JP11 to clear the CMOS contents. *Note that the ATX-power connector should be disconnected from the board before clearing CMOS.*

JP11	Setting	Function
	Pin 1-2 Short/Closed	Normal
	Pin 2-3 Short/Closed	Clear CMOS

JP13: Compact Flash Mode Setting

JP13	CF Mode
 Open	Slave
 Short	Master

J13: Intel® 82541GI Gigabit LAN Enable/Disable

J13	Gigabit LAN
	Enable
	Disable

Connectors on MB890

The connectors on MB890 allows you to connect external devices such as keyboard, floppy disk drives, hard disk drives, printers, etc. The following table lists the connectors on MB890 and their respective functions.

Connector Locations on MB890	14
CN1: DC Jack for DC Adaptor	15
CN2: PS/2 Keyboard and PS/2 Mouse Connectors.....	15
CN3: DVI-I Connector	15
CN4: Parallel Port Connector	16
CN5, CN8: 1394 Connectors (option).....	16
CN6: RJ45 and 2 USB Ports.....	16
CN7: COM1 and COM2 Serial Ports.....	16
J2: HDD Power Connector	17
J3: Internal DC-In Power Connector	17
J5: LCD Backlight Setting.....	17
J6, J8: LVDS Connectors (1st channel, 2nd channel)	18
J7: IrDA Connector	18
J10: Digital I/O	18
J11, J12: USB Port Pin Header	18
J16: HDD Power Pin Header	19
J17: Mini PCI Socket	19
J18, J19: Primary and Secondary IDE Connectors	19
J20: CD-In Pin Header	20
J21: External Audio Connector	20
J22: System Function Connector	21
J23: Wake On LAN Connector	23
J24: Compact Flash Socket.....	23
J25: VGA CRT Connector.....	23
FAN1: CPU Fan Power Connector	23
FAN2: System Fan Power Connector.....	23

Connector Locations on MB890

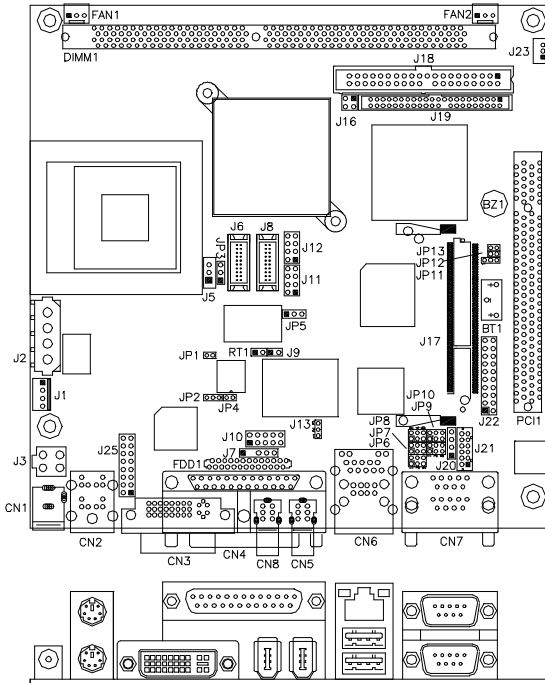

Connectors on MB890.....	Page
CN1: DC Jack for DC Adaptor	15
CN2: PS/2 Keyboard and PS/2 Mouse Connectors	15
CN3: DVI-I Connector.....	15
CN4: Parallel Port Connector.....	16
CN5, CN8: 1394 Connectors (option)	16
CN6: RJ45 and 2 USB Ports	16
CN7: COM1 and COM2 Serial Ports	16
J2: HDD Power Connector.....	17
J3: Internal DC-In Power Connector.....	17
J5: LCD Backlight Setting.....	17
J6, J8: LVDS Connectors (1st channel, 2nd channel).....	18
J7: IrDA Connector	18
J10: Digital I/O.....	18
J11, J12: USB Port Pin Header	18
J16: HDD Power Pin Header	19
J17: Mini PCI Socket	19
J18, J19: Primary and Secondary IDE Connectors.....	19
J20: CD-In Pin Header.....	20
J21: External Audio Connector	20
J22: System Function Connector.....	21
J23: Wake On LAN Connector	23
J24: Compact Flash Socket	23
J25: VGA CRT Connector	23
FAN1: CPU Fan Power Connector	23
FAN2: System Fan Power Connector	23

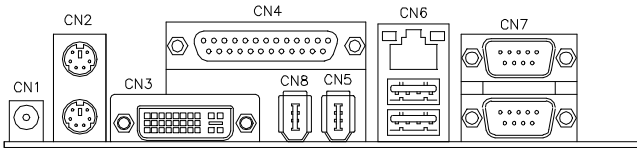

CN1: DC Jack for DC Adaptor

The DC jack accepts input of 12V or 19V.

CN2: PS/2 Keyboard and PS/2 Mouse Connectors



PS/2 Mouse

PS/2 Keyboard

Signal Name	Keyboard	Mouse	Signal Name
Keyboard data	1	1	Mouse data
N.C.	2	2	N.C.
GND	3	3	GND
5V	4	4	5V
Keyboard clock	5	5	Mouse clock
N.C.	6	6	N.C.

CN3: DVI-I Connector

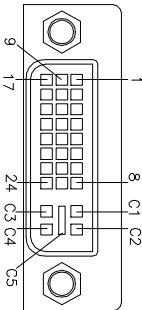

Signal Name	Pin #	Pin #	Signal Name
DATA 2-	1	16	HOT POWER
DATA 2+	2	17	DATA 0-
Shield 2/4	3	18	DATA 0+
DATA 4-	4	19	SHIELD 0/5
DATA 4+	5	20	DATA 5-
DDC CLOCK	6	21	DATA 5+
DDC DATA	7	22	SHIELD CLK
VSYNC	8	23	CLOCK -
DATA 1-	9	24	CLOCK +
DATA 1+	10	C1	A RED
SHIELD 1/3	11	C2	A GREEN
DATA 3-	12	C3	A BLUE
DATA 3+	13	C4	HYNC
DDC POWER	14	C5	A GROUND2
A GROUND 1	15	C6	A GROUND3

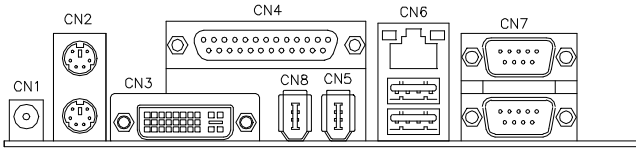

CN4: Parallel Port Connector

Signal Name	Pin #	Pin #	Signal Name
Line printer strobe	1	14	AutoFeed
PD0, parallel data 0	2	15	Error
PD1, parallel data 1	3	16	Initialize
PD2, parallel data 2	4	17	Select
PD3, parallel data 3	5	18	Ground
PD4, parallel data 4	6	19	Ground
PD5, parallel data 5	7	20	Ground
PD6, parallel data 6	8	21	Ground
PD7, parallel data 7	9	22	Ground
ACK, acknowledge	10	23	Ground
Busy	11	24	Ground
Paper empty	12	25	Ground
Select	13	N/A	N/A

CN5, CN8: 1394 Connectors (option)

CN6: RJ45 and 2 USB Ports

CN6 is a stacked connector with RJ45 on top and 2 USB ports at the bottom.

CN7: COM1 and COM2 Serial Ports

CN7 is a stacked connector with COM1 on top and COM2 at the bottom.

Signal Name	Pin #	Pin #	Signal Name
DCD, Data carrier detect	1	6	DSR, Data set ready
RXD, Receive data	2	7	RTS, Request to send
TXD, Transmit data	3	8	CTS, Clear to send
DTR, Data terminal ready	4	9	RI, Ring indicator
GND, ground	5	10	Not Used

COM2 is jumper selectable for RS-232, RS-422 and RS-485.

Pin #	Signal Name		
	RS-232	R2-422	RS-485
1	DCD	TX-	DATA-
2	RX	TX+	DATA+
3	TX	RX+	NC
4	DTR	RX-	NC
5	Ground	Ground	Ground
6	DSR	RTS-	NC
7	RTS	RTS+	NC
8	CTS	CTS+	NC
9	RI	CTS-	NC
10	NC	NC	NC

J2: HDD Power Connector



Pin #	Signal Name
1	+12V
2	Ground
3	Ground
4	5V

J3: Internal DC-In Power Connector

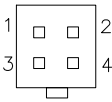

Pin #	Signal Name
1	Ground
2	Ground
3	+12V or 19V
4	+12V or 19V

J5: LCD Backlight Setting



Pin #	Signal Name
1	+12V
2	Backlight Enable
3	Ground

J6, J8: LVDS Connectors (1st channel, 2nd channel)

The LVDS connectors on board consist of the first channel (J6) and second channel (J8) and supports 24-bit or 48-bit.

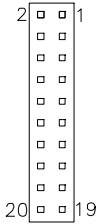

Signal Name	Pin #	Pin #	Signal Name
TX0-	2	1	TX0+
Ground	4	3	Ground
TX1-	6	5	TX1+
5V/3.3V	8	7	Ground
TX3-	10	9	TX3+
TX2-	12	11	TX2+
Ground	14	13	Ground
TXC-	16	15	TXC+
5V/3.3V	18	17	ENABKL
+12V	20	19	+12V

J7: IrDA Connector

J7 is used for an optional IrDA connector for wireless communication.

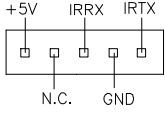

Pin #	Signal Name
1	+5V
2	No connect
3	Ir RX
4	Ground
5	Ir TX

J10: Digital I/O



Signal Name	Pin	Pin	Signal Name
GND	1	2	VCC
OUT3	3	4	OUT1
OUT2	5	6	OUT0
IN3	7	8	IN1
IN2	9	10	IN0

J11, J12: USB Port Pin Header



Signal Name	Pin	Pin	Signal Name
Vcc	1	5	Ground
D-	2	6	D+
D+	3	7	D-
Ground	4	8	Vcc

J16: HDD Power Pin Header



Signal Name	Pin	Pin	Signal Name
Vcc	2	1	Vcc
NC	4	3	Ground

J17: Mini PCI Socket

J18, J19: Primary and Secondary IDE Connectors

J18: Primary IDE Connector

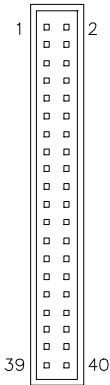

Signal Name	Pin #	Pin #	Signal Name
Reset IDE	1	2	Ground
Host data 7	3	4	Host data 8
Host data 6	5	6	Host data 9
Host data 5	7	8	Host data 10
Host data 4	9	10	Host data 11
Host data 3	11	12	Host data 12
Host data 2	13	14	Host data 13
Host data 1	15	16	Host data 14
Host data 0	17	18	Host data 15
Ground	19	20	Protect pin
DRQ0	21	22	Ground
Host IOW	23	24	Ground
Host IOR	25	26	Ground
IOCHRDY	27	28	Host ALE
DACK0	29	30	Ground
IRQ14	31	32	No connect
Address 1	33	34	No connect
Address 0	35	36	Address 2
Chip select 0	37	38	Chip select 1
Activity	39	40	Ground

J19: Secondary IDE Connector

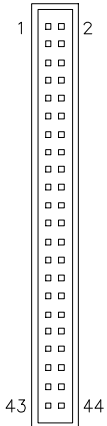

Signal Name	Pin #	Pin #	Signal Name
Reset IDE	1	2	Ground
Host data 7	3	4	Host data 8
Host data 6	5	6	Host data 9
Host data 5	7	8	Host data 10
Host data 4	9	10	Host data 11
Host data 3	11	12	Host data 12
Host data 2	13	14	Host data 13
Host data 1	15	16	Host data 14
Host data 0	17	18	Host data 15
Ground	19	20	Key
DRQ0	21	22	Ground
Host IOW	23	24	Ground
Host IOR	25	26	Ground
IOCHRDY	27	28	Host ALE
DACK0	29	30	Ground
IRQ14	31	32	No connect
Address 1	33	34	No connect
Address 0	35	36	Address 2
Chip select 0	37	38	Chip select 1
Activity	39	40	Ground
Vcc	41	42	Vcc
Ground	43	44	N.C.

J20: CD-In Pin Header

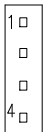

Pin #	Signal Name
1	CD Audio R
2	Ground
3	Ground
4	CD Audio L

J21: External Audio Connector

J21 is a 12-pin header that is used to connect to the optional audio cable card that integrates jacks for Line In, Line Out and Mic.

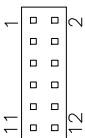

Signal Name	Pin #	Pin #	Signal Name
LINEOUT_R	1	2	LINEOUT_L
Ground	3	4	Ground
LINEIN_R	5	6	LINEIN_L
Ground	7	8	Ground
Mic-In	9	10	VREFOUT
Ground	11	12	Protect pin

J22: System Function Connector

J22 provides connectors for system indicators that provide light indication of the computer activities and switches to change the computer status. J22 is a 20-pin header that provides interfaces for the following functions.

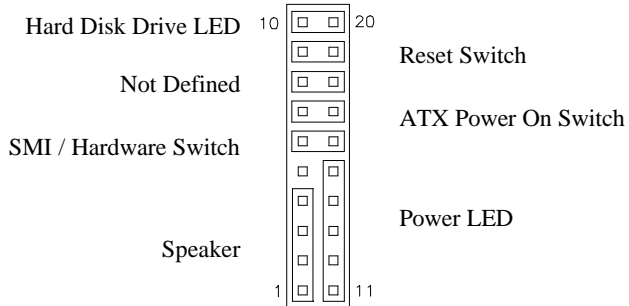

Speaker: Pins 1 - 4

This connector provides an interface to a speaker for audio tone generation. An 8-ohm speaker is recommended.

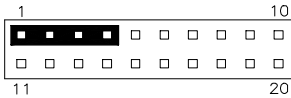

Pin #	Signal Name
1	Speaker out
2	No connect
3	Ground
4	+5V

Power LED: Pins 11 - 15

The power LED indicates the status of the main power switch.

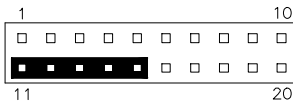

Pin #	Signal Name
11	Power LED
12	No connect
13	Ground
14	No connect
15	Ground

SMI/Hardware Switch: Pins 6 and 16

This connector supports the "Green Switch" on the control panel, which, when pressed, will force the system into the power-saving mode immediately.

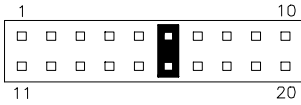

Pin #	Signal Name
6	SMI
16	Ground

ATX Power ON Switch: Pins 7 and 17

This 2-pin connector is an "ATX Power Supply On/Off Switch" on the system that connects to the power switch on the case. When pressed, the power switch will force the system to power on. When pressed again, it will force the system to power off.

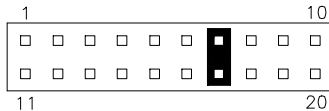

Reset Switch: Pins 9 and 19

The reset switch allows the user to reset the system without turning the main power switch off and then on again. Orientation is not required when making a connection to this header.

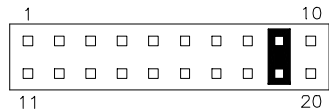

Hard Disk Drive LED Connector: Pins 10 and 20

This connector connects to the hard drive activity LED on control panel. This LED will flash when the HDD is being accessed.

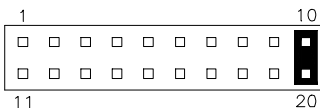

Pin #	Signal Name
10	HDD Active
20	5V

J23: Wake On LAN Connector

J23 is a 3-pin header for the Wake On LAN function. Wake On LAN will function properly only with an ATX power supply with 5VSB that has 200mA.

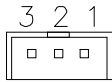

Pin #	Signal Name
1	+5VSB
2	Ground
3	-PME

J24: Compact Flash Socket

J25: VGA CRT Connector

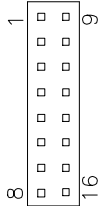

Signal Name	Pin	Pin	Signal Name
R	1	9	+5V
G	2	10	GND
B	3	11	NC
NC	4	12	DCCDAT
GND	5	13	HSYNC
GND	6	14	VSYNC
GND	7	15	DCCCLK
GND	8	16	TV out

FAN1: CPU Fan Power Connector

FAN1 is a 3-pin header for the CPU fan. The fan must be a 12V fan.

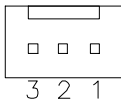

Pin #	Signal Name
1	Ground
2	+12V
3	Rotation detection

FAN2: System Fan Power Connector

FAN2 is a 3-pin header for system fans. The fan must be a 12V (500mA) fan.

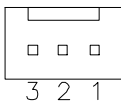

Pin #	Signal Name
1	Ground
2	+12V
3	Rotation detection

This page is intentionally left blank.

BIOS Setup

This chapter describes the different settings available in the Award BIOS that comes with the board. The topics covered in this chapter are as follows:

BIOS Introduction	26
BIOS Setup	26
Standard CMOS Setup	28
Advanced BIOS Features.....	31
Advanced Chipset Features	34
Integrated Peripherals	37
Power Management Setup	41
PNP/PCI Configurations	44
PC Health Status	45
Frequency/Voltage Control.....	46
Load Fail-Safe Defaults.....	47
Load Optimized Defaults.....	47
Set Supervisor/User Password	47
Save & Exit Setup	47
Exit Without Saving.....	47

BIOS Introduction

The Award BIOS (Basic Input/Output System) installed in your computer system's ROM supports Intel processors. The BIOS provides critical low-level support for a standard device such as disk drives, serial ports and parallel ports. It also adds virus and password protection as well as special support for detailed fine-tuning of the chipset controlling the entire system.

BIOS Setup

The Award BIOS provides a Setup utility program for specifying the system configurations and settings. The BIOS ROM of the system stores the Setup utility. When you turn on the computer, the Award BIOS is immediately activated. Pressing the key immediately allows you to enter the Setup utility. If you are a little bit late pressing the key, POST (Power On Self Test) will continue with its test routines, thus preventing you from invoking the Setup. If you still wish to enter Setup, restart the system by pressing the "Reset" button or simultaneously pressing the <Ctrl>, <Alt> and <Delete> keys. You can also restart by turning the system Off and back On again. The following message will appear on the screen:

Press to Enter Setup

In general, you press the arrow keys to highlight items, <Enter> to select, the <PgUp> and <PgDn> keys to change entries, <F1> for help and <Esc> to quit.

When you enter the Setup utility, the Main Menu screen will appear on the screen. The Main Menu allows you to select from various setup functions and exit choices.

Phoenix - AwardBIOS CMOS Setup Utility

Standard CMOS Features	Frequency/Voltage Control
Advanced BIOS Features	Load Fail-Safe Defaults
Advanced Chipset Features	Load Optimized Defaults
Integrated Peripherals	Set Supervisor Password
Power Management Setup	Set User Password
PnP/PCI Configurations	Save & Exit Setup
PC Health Status	Exit Without Saving
ESC : Quit	↑ ↓ → ← : Select Item
F10 : Save & Exit Setup	
Time, Date, Hard Disk Type...	

The section below the setup items of the Main Menu displays the control keys for this menu. At the bottom of the Main Menu just below the control keys section, there is another section, which displays information on the currently highlighted item in the list.

Note: *If the system cannot boot after making and saving system changes with Setup, the Award BIOS supports an override to the CMOS settings that resets your system to its default.*

Warning: *It is strongly recommended that you avoid making any changes to the chipset defaults. These defaults have been carefully chosen by both Award and your system manufacturer to provide the absolute maximum performance and reliability. Changing the defaults could cause the system to become unstable and crash in some cases.*

Standard CMOS Setup

“Standard CMOS Setup” choice allows you to record some basic hardware configurations in your computer system and set the system clock and error handling. If the motherboard is already installed in a working system, you will not need to select this option. You will need to run the Standard CMOS option, however, if you change your system hardware configurations, the onboard battery fails, or the configuration stored in the CMOS memory was lost or damaged.

Phoenix - AwardBIOS CMOS Setup Utility
Standard CMOS Features

		Item Help
Date (mm:dd:yy)	Wed, Apr 28, 2004	Menu Level > Change the day, month, Year and century
Time (hh:mm:ss)	00 : 00 : 00	
IDE Primary Master	None	
IDE Primary Slave	None	
IDE Secondary Master	None	
IDE Secondary Slave	None	
Drive A	1.44M, 3.5 in.	
Drive B	None	
Video	EGA/VGA	
Halt On	All Errors	
Base Memory	640K	
Extended Memory	129024K	
Total Memory	130048K	

At the bottom of the menu are the control keys for use on this menu. If you need any help in each item field, you can press the <F1> key. It will display the relevant information to help you. The memory display at the lower right-hand side of the menu is read-only. It will adjust automatically according to the memory changed. The following describes each item of this menu.

Date

The date format is:

Day : Sun to Sat
Month : 1 to 12
Date : 1 to 31
Year : 1999 to 2099

To set the date, highlight the “Date” field and use the PageUp/PageDown or +/- keys to set the current time.

Time

The time format is: **Hour : 00 to 23**
Minute : 00 to 59
Second : 00 to 59

To set the time, highlight the “Time” field and use the <PgUp>/<PgDn> or +/- keys to set the current time.

IDE Primary HDDs / IDE Secondary HDDs

The onboard PCI IDE connectors provide Primary and Secondary channels for connecting up to four IDE hard disks or other IDE devices. Each channel can support up to two hard disks; the first is the “Master” and the second is the “Slave”.

Press <Enter> to configure the hard disk. The selections include Auto, Manual, and None. Select ‘Manual’ to define the drive information manually. You will be asked to enter the following items.

CYLS : Number of cylinders
HEAD : Number of read/write heads
PRECOMP : Write precompensation
LANDING ZONE : Landing zone
SECTOR : Number of sectors

The Access Mode selections are as follows:

CHS (HD < 528MB)
LBA (HD > 528MB and supports
 Logical Block Addressing)
Large (for MS-DOS only)
Auto

Remarks: The main board supports two serial ATA ports and are represented in this setting as IDE Channel 2 / 3 Master.

Drive A / Drive B

These fields identify the types of floppy disk drive A or drive B that has been installed in the computer. The available specifications are:

360KB 1.2MB 720KB 1.44MB 2.88MB
5.25 in. 5.25 in. 3.5 in. 3.5 in. 3.5 in.

Video

This field selects the type of video display card installed in your system.

You can choose the following video display cards:

EGA/VGA	For EGA, VGA, SEGA, SVGA or PGA monitor adapters. (default)
CGA 40	Power up in 40 column mode.
CGA 80	Power up in 80 column mode.
MONO	For Hercules or MDA adapters.

Halt On

This field determines whether or not the system will halt if an error is detected during power up.

No errors	The system boot will not be halted for any error that may be detected.
All errors	Whenever the BIOS detects a non-fatal error, the system will stop and you will be prompted.
All, But Keyboard	The system boot will not be halted for a keyboard error; it will stop for all other errors
All, But Diskette	The system boot will not be halted for a disk error; it will stop for all other errors.
All, But Disk/Key	The system boot will not be halted for a keyboard or disk error; it will stop for all others.

Advanced BIOS Features

This section allows you to configure and improve your system and allows you to set up some system features according to your preference.

Phoenix - AwardBIOS CMOS Setup Utility
Advanced BIOS Features

		ITEM HELP
CPU Feature	Press Enter	
Virus Warning	Disabled	Menu Level >
CPU L1 and L2 Cache	Enabled	
CPU L3 Cache	Enabled	
Quick Power On Self Test	Enabled	
First Boot Device	Floppy	
Second Boot Device	HDD-0	
Third Boot Device	CDROM	
Boot Other Device	Enabled	
Swap Floppy Drive	Disabled	
Boot Up Floppy Seek	Disabled	
Boot Up NumLock Status	On	
Gate A20 Option	Fast	
Typematic Rate Setting	Disabled	
Typematic Rate (Chars/Sec)	6	
Typematic Delay (Msec)	250	
Security Option	Setup	
APIC Mode	Enabled	
MPS Version Control for OS	1.4	
OS Select For DRAM>64MB	Non-OS2	
Report No FDD For WIN 95	Yes	
Small Logo (EPA) Show	Enabled	

CPU Feature

Press Enter to configure the settings relevant to CPU Feature.

Virus Warning

If this option is enabled, an alarm message will be displayed when trying to write on the boot sector or on the partition table on the disk, which is typical of the virus.

CPU L1 and L2 Cache / CPU L3 Cache

Cache memory is additional memory that is much faster than conventional DRAM (system memory). CPUs from 486-type on up contain internal cache memory, and most, but not all, modern PCs have additional (external) cache memory. When the CPU requests data, the system transfers the requested data from the main DRAM into cache memory, for even faster access by the CPU. These items allow you to enable (speed up memory access) or disable the cache function. By default, these items are Enabled.

Quick Power On Self Test

When enabled, this field speeds up the Power On Self Test (POST) after the system is turned on. If it is set to *Enabled*, BIOS will skip some items.

First/Second/Third Boot Device

These fields determine the drive that the system searches first for an operating system. The options available include *Floppy*, *LS120*, *HDD-0*, *SCSI*, *CDROM*, *HDD-1*, *HDD-2*, *HDD-3*, *ZIP100*, *USB-FDD*, *USB-CDROM*, *USB-HDD* and *Disable*.

Boot Other Device

These fields allow the system to search for an OS from other devices other than the ones selected in the First/Second/Third Boot Device.

Swap Floppy Drive

This item allows you to determine whether or not to enable Swap Floppy Drive. When enabled, the BIOS swaps floppy drive assignments so that Drive A becomes Drive B, and Drive B becomes Drive A. By default, this field is set to *Disabled*.

Boot Up Floppy Seek

This feature controls whether the BIOS checks for a floppy drive while booting up. If it cannot detect one (either due to improper configuration or its absence), it will flash an error message.

Boot Up NumLock Status

This allows you to activate the NumLock function after you power up the system.

Gate A20 Option

This field allows you to select how Gate A20 is worked. Gate A20 is a device used to address memory above 1 MB.

Typematic Rate Setting

When disabled, continually holding down a key on your keyboard will generate only one instance. When enabled, you can set the two typematic controls listed next. By default, this field is set to *Disabled*.

Typematic Rate (Chars/Sec)

When the typematic rate is enabled, the system registers repeated keystrokes speeds. Settings are from 6 to 30 characters per second.

Typematic Delay (Msec)

When the typematic rate is enabled, this item allows you to set the time interval for displaying the first and second characters. By default, this item is set to *250msec*.

Security Option

This field allows you to limit access to the System and Setup. The default value is *Setup*. When you select *System*, the system prompts for the User Password every time you boot up. When you select *Setup*, the system always boots up and prompts for the Supervisor Password only when the Setup utility is called up.

APIC Mode

APIC stands for Advanced Programmable Interrupt Controller. The default setting is *Enabled*.

MPS Version Control for OS

This option specifies the MPS (Multiprocessor Specification) version for your operating system. MPS version 1.4 added extended configuration tables to improve support for multiple PCI bus configurations and improve future expandability. The default setting is *1.4*.

OS Select for DRAM > 64MB

This option allows the system to access greater than 64MB of DRAM memory when used with OS/2 that depends on certain BIOS calls to access memory. The default setting is *Non-OS/2*.

Report No FDD For WIN 95

If you are using Windows 95/98 without a floppy disk drive, select Enabled to release IRQ6. This is required to pass Windows 95/98's SCT test. You should also disable the Onboard FDC Controller in the Integrated Peripherals screen when there's no floppy drive in the system. If you set this feature to Disabled, the BIOS will not report the missing floppy drive to Win95/98.

Small Logo (EPA) Show

The EPA logo appears at the right side of the monitor screen when the system is boot up. The default setting is *Enabled*.

Advanced Chipset Features

This Setup menu controls the configuration of the chipset.

Phoenix - AwardBIOS CMOS Setup Utility
Advanced Chipset Features

		ITEM HELP
DRAM Timing Selectable	By SPD	Menu Level >
CAS Latency Time	2	
Active to Precharge Delay	6	
DRAM RAS# to CAS# Delay	3	
DRAM RAS# Precharge	3	
DRAM Data Integrity Mode	ECC	
MGM Core Frequency	Auto Max 266MHz	
System BIOS Cacheable	Enabled	
Video BIOS Cacheable	Enabled	
Memory Hole at 15M-16M	Disabled	
Delayed Transaction	Enabled	
Delay Prior to Thermal	16 Min	
AGP Aperture Size (MB)	64	
** On-Chip VGA Setting **		
On-Chip VGA	Enabled	
On-Chip Frame Buffer Size	32MB	
Boot Display	CRT+DVI	
TV Standard	Off	
Video Connector	Automatic	
TV Format	Auto	
Panel Scaling	Auto	
Panel Number	1024x768 18bit SC	

DRAM Timing Selectable

This option refers to the method by which the DRAM timing is selected. The default is **By SPD**.

CAS Latency Time

You can configure CAS latency time in HCLKs as 2 or 2.5 or 3. The system board designer should set the values in this field, depending on the DRAM installed. Do not change the values in this field unless you change specifications of the installed DRAM or the installed CPU.

Active to Precharge Delay

The default setting for the Active to Precharge Delay is **7**.

DRAM RAS# to CAS# Delay

This option allows you to insert a delay between the RAS (Row Address Strobe) and CAS (Column Address Strobe) signals. This delay occurs when the SDRAM is written to, read from or refreshed. Reducing the delay improves the performance of the SDRAM.

DRAM RAS# Precharge

This option sets the number of cycles required for the RAS to accumulate its charge before the SDRAM refreshes. The default setting for the Active to Precharge Delay is 3.

DRAM Data Integrity Mode

Select ECC if your memory module supports it. The memory controller will detect and correct single-bit soft memory errors. The memory controller will also be able to detect double-bit errors though it will not be able to correct them. This provides increased data integrity and system stability.

MGM Core Frequency

This field sets the frequency of the DRAM memory installed. The default setting is *Auto Max 266MHz*.

System BIOS Cacheable

The setting of *Enabled* allows caching of the system BIOS ROM at F000h-FFFFh, resulting in better system performance. However, if any program writes to this memory area, a system error may result.

Video BIOS Cacheable

The Setting *Enabled* allows caching of the video BIOS ROM at C0000h-F7FFFh, resulting in better video performance. However, if any program writes to this memory area, a system error may result.

Memory Hole At 15M-16M

In order to improve performance, certain space in memory can be reserved for ISA cards. This memory must be mapped into the memory space below 16 MB. The choices are *Enabled* and *Disabled*.

Delayed Transaction

The chipset has an embedded 32-bit posted write buffer to support delay transactions cycles. Select *Enabled* to support compliance with PCI specification version 2.1.

Delay Prior to Thermal

This field activates the CPU thermal function after the systems boots for the set number of minutes. The options are *16Min* and *64Min*.

AGP Aperture Size

The field sets aperture size of the graphics. The aperture is a portion of the PCI memory address range dedicated for graphics memory address space. Host cycles that hit the aperture range are forwarded to the AGP without any translation. The default setting is **64M**.

On-Chip VGA

The default setting is *Enabled*.

On-Chip Frame Buffer Size

The default setting is **32MB**. The options available include *1MB*, *4MB*, *8MB* and *16MB*.

Boot Display

The default setting is *CRT+DVI*. The options available include some combinations with LVDS and TV-out. The MB890 supports dual view (CRT with LVDS or TV-out).

TV Standard (on MB890F/FC version only)

The default setting is *Off*.

Video Connector (on MB890F/FC version only)

The default setting is *Automatic*.

TV Format (on MB890F/FC version only)

The default setting is *Auto*.

Panel Scaling

The default setting is *Auto*. The options available include *On* and *Off*.

Panel Number

These fields allow you to select the LCD Panel type. The default values for these ports are:

640x480	18bit SC
800x600	18bit SC
1024x768	18bit SC
1280x1024	24bit DC
1400x1050	18bit DC
1024x768	24bit SC
1600x1200	24bit DC
1280x1024	18bit DC

Integrated Peripherals

This section sets configurations for your hard disk and other integrated peripherals. The first screen shows three main items for user to select. Once an item selected, a submenu appears. Details follow.

Phoenix - AwardBIOS CMOS Setup Utility
Integrated Peripherals

OnChip IDE Device	Press Enter	ITEM HELP
Onboard Device	Press Enter	Menu Level >
SuperIO Device	Press Enter	

Phoenix - AwardBIOS CMOS Setup Utility
OnChip IDE Device

On-Chip Primary PCI IDE	Enabled	ITEM HELP
IDE Primary Master PIO	Auto	Menu Level >
IDE Primary Slave PIO	Auto	
IDE Primary Master UDMA	Auto	
IDE Primary Slave UDMA	Auto	
On-Chip Secondary PCI IDE	Enabled	
IDE Secondary Master PIO	Auto	
IDE Secondary Slave PIO	Auto	
IDE Secondary Master UDMA	Auto	
IDE Secondary Slave UDMA	Auto	
IDE HDD Block Mode	Enabled	

Phoenix - AwardBIOS CMOS Setup Utility
Onboard Device

USB Controller	Enabled	ITEM HELP
USB 2.0 Controller	Enabled	Menu Level >
USB Keyboard Support	Disabled	
USB Mouse Support	Disabled	
AC97 Audio	Auto	
Init Display First	PCI Slot	
Power On After Fail	Off	

Phoenix - AwardBIOS CMOS Setup Utility
SuperIO Device

Onboard FDC Controller	Enabled	ITEM HELP Menu Level >
Onboard Serial Port 1	3F8/IRQ4	
Onboard Serial Port 2	2F8/IRQ3	
UART Mode Select	Normal	
RxD , TxD Active	Hi, Lo	
IR Transmission Delay	Disabled	
UR2 Duplex Mode	Half	
Use IR Pins	IR-Rx2Tx2	
Onboard Parallel Port	378/IRQ7	
Parallel Port Mode	SPP	
EPP Mode Select	EPP1.7	
ECP Mode Use DMA	3	

OnChip Primary/Secondary PCI IDE

The integrated peripheral controller contains an IDE interface with support for two IDE channels. Select *Enabled* to activate each channel separately.

IDE Primary/Secondary Master/Slave PIO

These fields allow your system hard disk controller to work faster. Rather than have the BIOS issue a series of commands that transfer to or from the disk drive, PIO (Programmed Input/Output) allows the BIOS to communicate with the controller and CPU directly.

The system supports five modes, numbered from 0 (default) to 4, which primarily differ in timing. When Auto is selected, the BIOS will select the best available mode.

IDE Primary/Secondary Master/Slave UDMA

These fields allow your system to improve disk I/O throughput to 33Mb/sec with the Ultra DMA/33 feature. The options are *Auto* and *Disabled*.

IDE HDD Block Mode

This field allows your hard disk controller to use the fast block mode to transfer data to and from your hard disk drive.

USB Controller

The options for this field are *Enabled* and *Disabled*. By default, this field is set to *Enabled*.

USB 2.0 Controller

The options for this field are *Enabled* and *Disabled*. By default, this field is set to *Enabled*. In order to use USB 2.0, necessary OS drivers must be installed first. *Please update your system to Windows 2000 SP4 or Windows XP SP1.*

USB Keyboard Support

The options for this field are *Enabled* and *Disabled*. By default, this field is set to *Disabled*.

USB Mouse Support

The options for this field are *Enabled* and *Disabled*. By default, this field is set to *Disabled*.

AC97 Audio

The default setting of the AC97 Audio is *Auto*.

Init Display First

The default setting is *PCI Card*.

Power On After Fail

The setting configures the system power on status when power is restored to the system after a power failure occurrence. The default setting is *Off*.

Onboard FDC Controller

Select *Enabled* if your system has a floppy disk controller (FDC) installed on the motherboard and you wish to use it. If you install an add-in FDC or the system has no floppy drive, select *Disabled* in this field. This option allows you to select the onboard FDD port.

Onboard Serial/Parallel Port

These fields allow you to select the onboard serial and parallel ports and their addresses. The default values for these ports are:

Serial Port 1	3F8/IRQ4
Serial Port 2	2F8/IRQ3
Parallel Port	378H/IRQ7

UART Mode Select

This field determines the UART 2 mode in your computer. The default value is *Normal*. Other options include *IrDA* and *ASKIR*.

Parallel Port Mode

This field allows you to determine parallel port mode function.

SPP	Standard Printer Port
EPP	Enhanced Parallel Port
ECP	Extended Capabilities Port

Power Management Setup

The Power Management Setup allows you to save energy of your system effectively.

Phoenix - AwardBIOS CMOS Setup Utility
Power Management Setup

Power-Supply Type	ATX	ITEM HELP
ACPI Function	Enabled	
Power Management	User Define	Menu Level >
Video Off Method	V/H SYNC+Blank	
Video Off In Suspend	Yes	
Suspend Type	Stop Grant	
Modem Use IRQ	3	
Suspend Mode	Disabled	
HDD Power Down	Disabled	
Soft-Off by PWR-BTTN	Instant-Off	
CPU THRM-Throttling	50%	
Wake-Up by PCI Card	Disabled	
Power On by Ring	Disabled	
Resume by Alarm	Disabled	
Date (of Month) Alarm	0	
Time (hh:mm:ss) Alarm	0 : 0 : 0	
** Reload Global Timer Events **		
Primary IDE 0	Enabled	
Primary IDE 1	Enabled	
Secondary IDE 0	Enabled	
Secondary IDE 1	Enabled	
FDD, COM, LPT Port	Enabled	
PCI PIRQ[A-D] #	Enabled	

Power Supply Type

Use this field to select the power supply type used in the system. The default setting is **ATX**.

ACPI Function

Enable this function to support ACPI (Advance Configuration and Power Interface).

Power Management

This field allows you to select the type of power saving management modes. There are four selections for Power Management.

Min. Power Saving	Minimum power management
Max. Power Saving	Maximum power management.
User Define	Each of the ranges is from 1 min. to 1hr. Except for HDD Power Down which ranges from 1 min. to 15 min.

Video Off Method

This field defines the Video Off features. There are three options.

V/H SYNC + Blank	Default setting, blank the screen and turn off vertical and horizontal scanning.
DPMS	Allows BIOS to control the video display.
Blank Screen	Writes blanks to the video buffer.

Video Off In Suspend

When enabled, the video is off in suspend mode. The default setting is *Yes*.

Suspend Type

The default setting for the Suspend Type field is *Stop Grant*.

Modem Use IRQ

This field sets the IRQ used by the Modem. By default, the setting is **3**.

Suspend Mode

When enabled, and after the set time of system inactivity, all devices except the CPU will be shut off.

HDD Power Down

When enabled, and after the set time of system inactivity, the hard disk drive will be powered down while all other devices remain active.

Soft-Off by PWRBTN

This field defines the power-off mode when using an ATX power supply. The *Instant Off* mode allows powering off immediately upon pressing the power button. In the *Delay 4 Sec* mode, the system powers off when the power button is pressed for more than four seconds or enters the suspend mode when pressed for less than 4 seconds.

CPU THRM-Throttling

When the system enters Doze mode, the CPU clock runs only part of the time. You may select the percent of time that the clock runs.

Wake up by PCI Card

By default, this field is disabled.

Power On by Ring

This field enables or disables the power on of the system through the modem connected to the serial port or LAN.

Resume by Alarm

This field enables or disables the resumption of the system operation. When enabled, the user is allowed to set the *Date* and *Time*.

Reload Global Timer Events

The HDD, FDD, COM, LPT Ports, and PCI PIRQ are I/O events that can prevent the system from entering a power saving mode or can awaken the system from such a mode. When an I/O device wants to gain the attention of the operating system, it signals this by causing an IRQ to occur. When the operating system is ready to respond to the request, it interrupts itself and performs the service.

PNP/PCI Configurations

This option configures the PCI bus system. All PCI bus systems on the system use INT#, thus all installed PCI cards must be set to this value.

Phoenix - AwardBIOS CMOS Setup Utility
PnP/PCI Configurations

Reset Configuration Data	Disabled	ITEM HELP
Resources Controlled By IRQ Resources	Auto (ESCD) Press Enter	Menu Level
PCI/VGA Palette Snoop	Disabled	Select Yes if you are using a Plug and Play capable operating system Select No if you need the BIOS to configure non-boot devices

Reset Configuration Data

This field allows you to determine whether to reset the configuration data or not. The default value is **Disabled**.

Resources Controlled by

This PnP BIOS can configure all of the boot and compatible devices automatically with the use of a use a PnP operating system such as Windows 95.

PCI/VGA Palette Snoop

Some non-standard VGA display cards may not show colors properly. This field allows you to set whether or not MPEG ISA/VESA VGA cards can work with PCI/VGA. When this field is enabled, a PCI/VGA can work with an MPEG ISA/VESA VGA card. When this field is disabled, a PCI/VGA cannot work with an MPEG ISA/VESA card.

PC Health Status

This section shows the parameters in determining the PC Health Status. These parameters include temperatures, fan speeds and voltages.

Phoenix - AwardBIOS CMOS Setup Utility
PC Health Status

		ITEM HELP
CPU Warning Temperature	85°C	Menu Level >
Shutdown Temperature	Disabled	
System Temp.	45°C/113°F	
CPU Temp	52°C/125°F	
FAN1 Speed	5400 RPM	
FAN2 Speed	5463 RPM	
FAN3 Speed	5388 RPM	
Vcore(V)	1.02 V	
VGMCH(V)	1.32 V	
+3.3V	3.32 V	
+5V	4.94 V	
+12V	12.03 V	
VBAT	3.21 V	
5VSB(V)	4.96 V	
Smart Fan1 Temp	Disabled	
Smart Fan2 Temp	Disabled	

CPU Warning Temperature

This field allows the user to set the temperature so that when the temperature is reached, the system sounds a warning. This function can help prevent damage to the system that is caused by overheating.

Temperatures/Voltages

These fields are the parameters of the hardware monitoring function feature of the motherboard. The values are read-only values as monitored by the system and show the PC health status.

Shutdown Temperature

This field allows the user to set the temperature by which the system automatically shuts down once the threshold temperature is reached. This function can help prevent damage to the system that is caused by overheating.

Smart Fan Temperature

This field enables or disables the smart fan feature. At a certain temperature, the fan starts turning. Once the temperature drops to a certain level, it stops turning again.

Frequency/Voltage Control

This section shows the user how to configure the processor frequency.

Phoenix - AwardBIOS CMOS Setup Utility
Frequency/Voltage Control

Auto Detect PCI Clk	Disabled	ITEM HELP
Spread Spectrum Modulated	Disabled	Menu Level >

Auto Detect PCI Clk

This field enables or disables the auto detection of the PCI clock.

Spread Spectrum Modulated

This field sets the value of the spread spectrum. The default setting is *Disabled*. This field is for CE testing use only.

Load Fail-Safe Defaults

This option allows you to load the troubleshooting default values permanently stored in the BIOS ROM. These default settings are non-optimal and disable all high-performance features.

Load Optimized Defaults

This option allows you to load the default values to your system configuration. These default settings are optimal and enable all high performance features.

Set Supervisor Password

These two options set the system password. Supervisor Password sets a password that will be used to protect the system and Setup utility. User Password sets a password that will be used exclusively on the system. To specify a password, highlight the type you want and press <Enter>. The Enter Password: message prompts on the screen. Type the password, up to eight characters in length, and press <Enter>. The system confirms your password by asking you to type it again. After setting a password, the screen automatically returns to the main screen.

To disable a password, just press the <Enter> key when you are prompted to enter the password. A message will confirm the password to be disabled. Once the password is disabled, the system will boot and you can enter Setup freely.

Save & Exit Setup

This option allows you to determine whether or not to accept the modifications. If you type “Y”, you will quit the setup utility and save all changes into the CMOS memory. If you type “N”, you will return to Setup utility.

Exit Without Saving

Select this option to exit the Setup utility without saving the changes you have made in this session. Typing “Y” will quit the Setup utility without saving the modifications. Typing “N” will return you to Setup utility.

This page is intentionally left blank.

Drivers Installation

This section describes the installation procedures for software and drivers under the Windows 98SE, Windows ME, Windows 2000 and Windows XP. The software and drivers are included with the motherboard. If you find the items missing, please contact the vendor where you made the purchase. The contents of this section include the following:

Intel Chipset Software Intallation Utility	50
VGA Drivers Installation	52
AC97 Codec Audio Driver Installation.....	53
Intel PRO LAN Drivers Installation	54

IMPORTANT NOTE:

After installing your Windows operating system (Windows 98SE/ME/2000/XP), you must install first the Intel Chipset Software Installation Utility before proceeding with the drivers installation.

Intel Chipset Software Installation Utility

The Intel Chipset Drivers should be installed first before the software drivers to enable Plug & Play INF support for Intel chipset components. Follow the instructions below to complete the installation under Windows 98SE/ME/2000/XP.

1. Insert the CD that comes with the board. Click **Intel Chipsets** and then **Intel(R) 855GME Chipset Drivers**.
2. Click **Intel(R) Chipset Software Installation Utility**.



3. When the Welcome screen appears, click **Next** to continue.

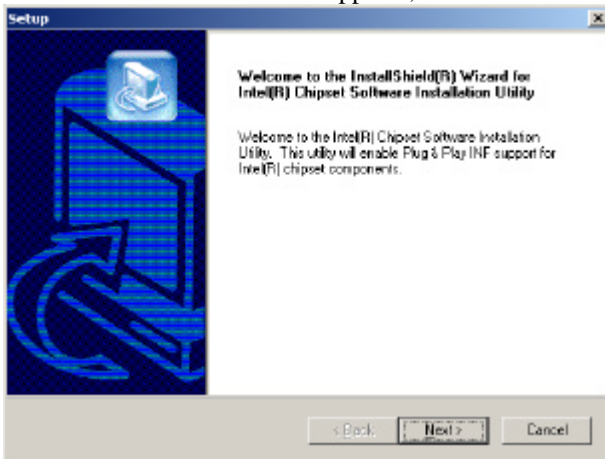

4. Click **Yes** to accept the software license agreement and proceed with the installation process.

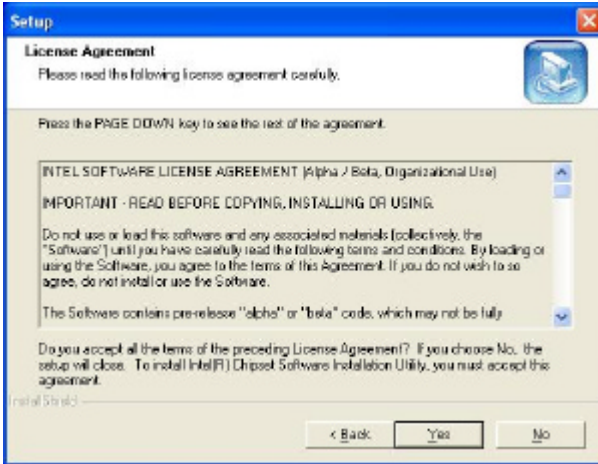

5. On Readme Information screen, click **Next** to continue the installation.

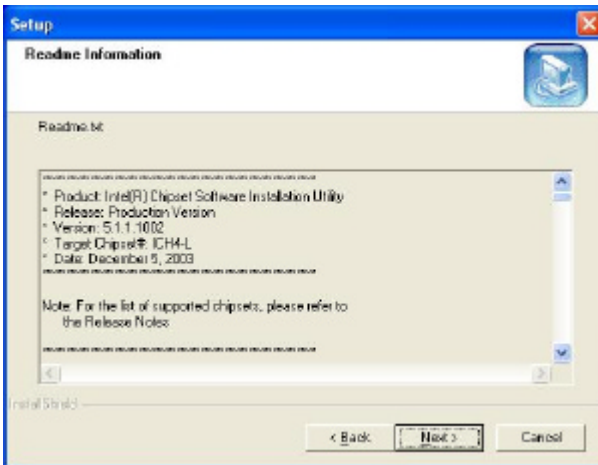

6. The Setup process is now complete. Click **Finish** to restart the computer and for changes to take effect. When the computer has restarted, the system will be able to find some devices. Restart your computer when prompted.

VGA Drivers Installation

To install the VGA drivers, follow the steps below to proceed with the installation.

1. Insert the CD that comes with the motherboard. Click **Intel Chipsets** and then **Intel(R) 855GME Chipset Drivers**.
2. Click **Intel(R) 855GME Chipset Family Graphics Driver**.

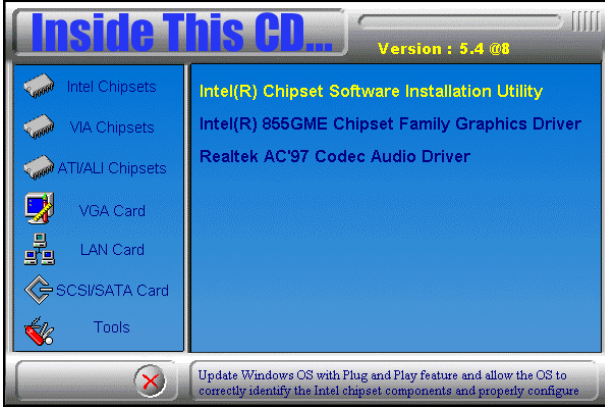

3. When the Welcome screen appears, click **Next** to continue.
4. Click **Yes** to agree with the license agreement and continue the installation.
5. Restart the computer as prompted and for changes to take effect.

AC97 Codec Audio Driver Installation

Follow the steps below to install the Realtek AC97 Codec Audio Drivers.

1. Insert the CD that comes with the motherboard. Click **Intel Chipsets** and then **Intel(R) 855GME Chipset Drivers**.
2. Click **Realtek AC'97 Codec Audio Driver**.

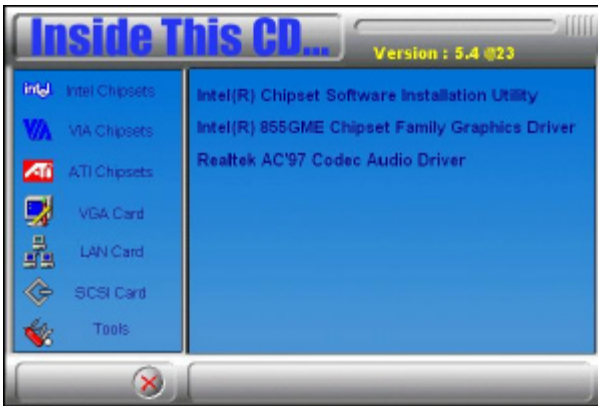

3. Click **Finish** to restart the computer and for changes to take effect. .

Intel PRO LAN Drivers Installation

Follow the steps below to complete the installation of the Intel PRO LAN drivers.

1. Insert the CD that comes with the motherboard. Click *LAN Card* and then *Intel(R) PRO LAN Drivers*.

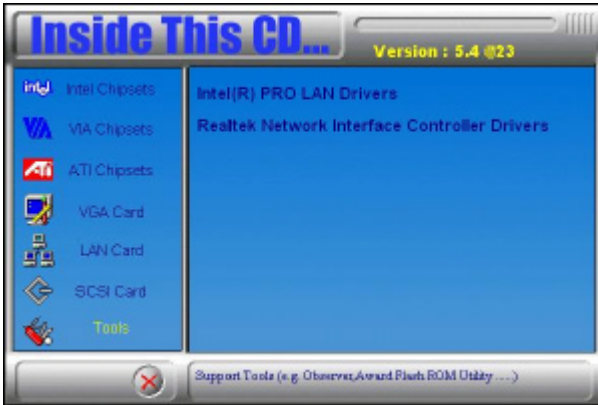

2. Click *Install Base Software* to continue.



3. When prompted, please to restart the computer for new settings to take effect.

Appendix

A. I/O Port Address Map

Each peripheral device in the system is assigned a set of I/O port addresses which also becomes the identity of the device. The following table lists the I/O port addresses used.

Address	Device Description
000h - 01Fh	DMA Controller #1
020h - 03Fh	Interrupt Controller #1
040h - 05Fh	Timer
060h - 06Fh	Keyboard Controller
070h - 07Fh	Real Time Clock, NMI
080h - 09Fh	DMA Page Register
0A0h - 0BFh	Interrupt Controller #2
0C0h - 0DFh	DMA Controller #2
0F0h	Clear Math Coprocessor Busy Signal
0F1h	Reset Math Coprocessor
1F0h - 1F7h	IDE Interface
278 - 27F	Parallel Port #2(LPT2)
2F8h - 2FFh	Serial Port #2(COM2)
2B0 - 2DF	Graphics adapter Controller
378h - 3FFh	Parallel Port #1(LPT1)
360 - 36F	Network Ports
3B0 - 3BF	Monochrome & Printer adapter
3C0 - 3CF	EGA adapter
3D0 - 3DF	CGA adapter
3F0h - 3F7h	Floppy Disk Controller
3F8h - 3FFh	Serial Port #1(COM1)

B. Interrupt Request Lines (IRQ)

Peripheral devices use interrupt request lines to notify CPU for the service required. The following table shows the IRQ used by the devices on board.

Level	Function
IRQ0	System Timer Output
IRQ1	Keyboard
IRQ2	Interrupt Cascade
IRQ3	Serial Port #2
IRQ4	Serial Port #1
IRQ5	Reserved
IRQ6	Floppy Disk Controller
IRQ7	Parallel Port #1
IRQ8	Real Time Clock
IRQ9	Reserved
IRQ10	Reserved
IRQ11	Reserved
IRQ12	PS/2 Mouse
IRQ13	80287
IRQ14	Primary IDE
IRQ15	Secondary IDE

C. Watchdog Timer Configuration

The WDT is used to generate a variety of output signals after a user programmable count. The WDT is suitable for use in the prevention of system lock-up, such as when software becomes trapped in a deadlock. Under these sort of circumstances, the timer will count to zero and the selected outputs will be driven. Under normal circumstance, the user will restart the WDT at regular intervals before the timer counts to zero.

SAMPLE CODE:

This code and information is provided "as is" without warranty of any kind, either expressed or implied, including but not limited to the implied warranties of merchantability and/or fitness for a particular purpose.

```

;[]=====
; Name : Enable_And_Set_Watchdog
; IN   : AL - 1sec ~ 255sec
; OUT  : None
;[]=====
Enable_And_Set_Watchdog Proc Near
    push    ax                ;save time interval
    call   Unlock_Chip

    mov     cl, 2Bh
    call   Read_Reg
    and     al, NOT 10h
    call   Write_Reg         ;set GP24 as WDTO

    mov     cl, 07h
    mov     al, 08h
    call   Write_Reg         ;switch to LD8

```

```

    mov cl, 0F5h
    call Read_Reg
    and    al, NOT 08h
    call Write_Reg      ;set count mode as second

    pop ax
    mov    cl, 0F6h
    call Write_Reg      ;set watchdog timer

    mov    al, 01h
    mov    cl, 30h
    call Write_Reg      ;watchdog enabled

    call Lock_Chip
    ret

Enable_And_Set_Watchdog Endp
;[]=====
; Name : Disable_Watchdog
; IN   : None
; OUT  : None
;[]=====
Disable_Watchdog Proc Near
    call Unlock_Chip

    mov    cl, 07h
    mov    al, 08h
    call Write_Reg      ;switch to LD8

    xor al, al
    mov    cl, 0F6h
    call Write_Reg      ;clear watchdog timer

    xor al, al
    mov    cl, 30h
    call Write_Reg      ;watchdog disabled

    call Lock_Chip
    ret
Disable_Watchdog Endp
;[]=====

```

```
; Name : Unlock_Chip
; IN : None
; OUT : None
;[]=====
Unlock_Chip Proc Near
    Mov dx, 4Eh
    mov al, 87h
    out dx, al
    out dx, al
    ret
Unlock_Chip Endp
;[]=====
; Name : Lock_Chip
; IN : None
; OUT : None
;[]=====
Unlock_Chip Proc Near
    mov dx, 4Eh
    mov al, 0AAh
    out dx, al
    ret
Unlock_Chip Endp
;[]=====
; Name : Write_Reg
; IN : CL - register index
; AL - Value to write
; OUT : None
;[]=====
Write_Reg Proc Near
    push ax
    mov dx, 4Eh
    mov al, cl
    out dx, al
    pop ax
    inc dx
    out dx, al
    ret
Write_Reg Endp
;[]=====
```

```
; Name : Read_Reg
; IN : CL - register index
; OUT  : AL - Value to read
;[]=====
===
Read_Reg Proc Near
    Mov al, cl
    mov  dx, 4Eh
    out dx, al
    inc dx
    in  al, dx
    ret
Read_Reg Endp
;[]=====
```

D. Digital I/O Sample Code

Filename: W627hf.h

```

=====
//
// THIS CODE AND INFORMATION IS PROVIDED "AS IS" WITHOUT WARRANTY OF ANY
// KIND, EITHER EXPRESSED OR IMPLIED, INCLUDING BUT NOT LIMITED TO THE
// IMPLIED WARRANTIES OF MERCHANTABILITY AND/OR FITNESS FOR A PARTICULAR
// PURPOSE.
//
=====
#ifndef __W627HF_H
#define __W627HF_H                1
=====
#define W627_IOBASE                0x4E
=====
#define W627HF_INDEX_PORT    (W627_IOBASE+0)
#define W627HF_DATA_PORT    (W627_IOBASE+1)
=====
#define W627HF_REG_LD        0x07
=====
#define W627HF_UNLOCK        0x87
#define W627HF_LOCK          0xAA
=====
void Set_W627HF_LD(unsigned char);
void Set_W627HF_Reg(unsigned char, unsigned char);
unsigned char Get_W627HF_Reg(unsigned char);
//
=====
#endif // __W627HF_H

```

Filename: W627hf.cpp

```
//=====
//
// THIS CODE AND INFORMATION IS PROVIDED "AS IS" WITHOUT WARRANTY OF ANY
// KIND, EITHER EXPRESSED OR IMPLIED, INCLUDING BUT NOT LIMITED TO THE
// IMPLIED WARRANTIES OF MERCHANTABILITY AND/OR FITNESS FOR A PARTICULAR
// PURPOSE.
//
//=====
#include "W627HF.H"
#include <dos.h>
//=====
void Unlock_W627HF (void);
void Lock_W627HF (void);
//=====
void Unlock_W627HF (void)
{
    outportb(W627HF_INDEX_PORT, W627HF_UNLOCK);
    outportb(W627HF_INDEX_PORT, W627HF_UNLOCK);
}
//=====
void Lock_W627HF (void)
{
    outportb(W627HF_INDEX_PORT, W627HF_LOCK);
}
//=====
void Set_W627HF_LD( unsigned char LD)
{
    Unlock_W627HF();
    outportb(W627HF_INDEX_PORT, W627HF_REG_LD);
    outportb(W627HF_DATA_PORT, LD);
    Lock_W627HF();
}
//=====
void Set_W627HF_Reg( unsigned char REG, unsigned char DATA)
{
    Unlock_W627HF();
    outportb(W627HF_INDEX_PORT, REG);
    outportb(W627HF_DATA_PORT, DATA);
    Lock_W627HF();
}
//=====
unsigned char Get_W627HF_Reg( unsigned char REG)
{
    unsigned char Result;
    Unlock_W627HF();
    outportb(W627HF_INDEX_PORT, REG);
    Result = inportb(W627HF_DATA_PORT);
    Lock_W627HF();
    return Result;
}
//=====
```

File of the Main.cpp

```

//=====
//
// THIS CODE AND INFORMATION IS PROVIDED "AS IS" WITHOUT WARRANTY OF ANY
// KIND, EITHER EXPRESSED OR IMPLIED, INCLUDING BUT NOT LIMITED TO THE
// IMPLIED WARRANTIES OF MERCHANTABILITY AND/OR FITNESS FOR A PARTICULAR
// PURPOSE.
//
//=====
#include <dos.h>
#include <conio.h>
#include <stdio.h>
#include <stdlib.h>
#include "W627HF.H"
//=====
void ClrKbBuf(void);
int main (int argc, char *argv[]);
//=====
int main (int argc, char *argv[])
{
    unsigned char ucDO = 0;           //data for digital output
    unsigned char ucDI;              //data for digital input
    unsigned char ucBuf;

    Set_W627HF_LD( 0x07);            //switch to logic device 7

    Set_W627HF_Reg(0xF1, 0x00);      //clear
    ucDI = Get_W627HF_Reg(0xF1) & 0x0F;

    ClrKbBuf();
    while(1)
    {
        ucDO++;
        Set_W627HF_Reg(0xF1, ((ucDO & 0x0F) << 4));
        ucBuf = Get_W627HF_Reg(0xF1) & 0x0F;
        if (ucBuf != ucDI)
        {
            ucDI = ucBuf;
            printf("Digital I/O Input Changed. Current Data is 0x%X\n",ucDI);
        }

        if (kbhit())
        {
            getch();
            break;
        }
        delay(500);
    }
    return 0;
}
//=====
void ClrKbBuf(void)
{
    while(kbhit())
    {    getch();    }
}
//-----

```

This page is intentionally left blank.