

# **MI987**

**Intel® Q87 / H81 Based Mini-ITX board  
Mini ITX Motherboard**

## **USER'S MANUAL**

**Version 1.0A**

---

## Acknowledgments

AMI is a registered trademark of American Megatrends Inc.  
PS/2 is a trademark of International Business Machines Corporation.

Intel and Intel® 4<sup>th</sup> Generation Core DC/QC Processor are registered trademarks of Intel Corporation.

Microsoft Windows is a registered trademark of Microsoft Corporation.

Fintek is a registered trademark of Fintek Electronics Corporation.

All other product names or trademarks are properties of their respective owners.

---

# Table of Contents

<b>Introduction .....</b>	<b>1</b>
Product Description.....	1
Checklist.....	1
MI987 Specifications .....	2
Board Dimensions .....	4
<b>Installations .....</b>	<b>5</b>
Installing the Memory .....	6
Setting the Jumpers .....	7
Connectors on MI987.....	12
<b>BIOS Setup.....</b>	<b>23</b>
<b>Drivers Installation .....</b>	<b>45</b>
Intel Chipset Software Installation Utility .....	46
VGA Drivers Installation .....	47
Realtek HD Audio Driver Installation .....	48
LAN Drivers Installation.....	49
Intel® Management Engine Interface .....	50
Intel® USB 3.0 Drivers.....	51
<b>Appendix.....</b>	<b>53</b>
A. I/O Port Address Map .....	53
B. Interrupt Request Lines (IRQ).....	54
C. Digital I/O Sample Code .....	55
D. Watchdog Timer Configuration .....	60

---

*This page is intentionally left blank.*

# Introduction

## Product Description

---

---

The MI987 Mini ITX motherboard is based on the latest Intel® Q87 chipset. The platform supports Intel® 4th Generation Core™ DT i7/i5/i3 processors.

The latest Intel® processors provide advanced performance in both computing and graphics quality. This meets the requirement of customers in the gaming, POS, digital signage and server market segment.

The platform supports two SO-DIMM sockets that can accommodate up to 16GB of DDR3-1600 Non-ECC memory. The Intel® 4th Gen. Core™ DT processor integrated HD graphics supports 3 independent displays, Direct X 11.1, OpenGL 3.2, and Open CL 1.2. Display interfaces are for HDMI, DisplayPort and VGA CRT.

With two Gigabit Ethernet, the MI987 Mini ITX board utilizes the dramatic increase in performance provided Intel's latest cutting-edge technology. Expansion is provided by PCIe(4x), one full sized MiniPCIe and two half sized MiniPCIe (One of half-sized MiniPCIe slot is dedicated mSATA only). Onboard connectors support 2x SATAIII, 4x or 6x USB 2.0 depending on the MI987 model and 2x COM ports. The board measures 170mm x 170mm.

## Checklist

---

---

Your MI987 package should include the items listed below.

- The MI987 MINI ITX motherboard
- This User's Manual
- 1 CD containing chipset drivers and flash memory utility

**MI987 Specifications**

<b>Product Name</b>	MI987AF (Q87) ( Model name printed on PCB surface) MI987EF (H81)
<b>Form Factor</b>	Mini ITX
<b>CPU Type</b>	- Intel® 4 <sup>th</sup> Generation Core™ DT i7/i5/i3 processors (22nm monolithic) **Recommend to use low power DT CPU @ TDP 35W/45W**
<b>CPU Speed</b>	Up to 2.7GHz
<b>Cache Size</b>	Up to 8MB
<b>CPU Socket</b>	LGA1150 (Socket H3)
<b>Chipset</b>	Intel® Q87 PCH [MI987AF] ; Intel® H81 PCH [MI987EF] Package =23 mm x 22 mm , 0.65 mm ball pitch
<b>BIOS</b>	AMI BIOS
<b>Memory</b>	Intel® 4 <sup>th</sup> Gen Core™ DT processors integrated memory controller, - DDR3-1600 MHz@1.5V - SO-DIMM x 2, Max.=16GB (Non-ECC) [Horizontal type]
<b>VGA</b>	Intel® 4 <sup>th</sup> Gen. Core™ DT processor integrated HD Gfx, supports 3 independent displays, Direct X 11.1, OpenGL 3.2, Open CL 1.2 - HDMI x 1 (w/ Level shifter PTN3360D) [Support to 4096 x 2304@24Hz ; 2560 x 1600@60Hz] - DisplayPort x 1 [support to 3820 x 2160@60Hz] - VGA x 1 (Thru PCH) [Support to 1920x1080@60Hz]
<b>LAN</b>	1. Intel® I217LM PHY[MI987AF] or I217V GbE PHY[MI987EF] 2. Intel® I211AT PCIe GbE as 2 <sup>nd</sup> LAN
<b>USB</b>	USB 2.0 host controller [ Q87/H81 Integrated] - [MI987AF] : 6 ports via onboard pin header - [MI987EF] : 4 ports thru pin header, 2 ports @edge I/O connectors - 2 ports via MiniPCIe socket USB 3.0 host controller [ Q87 /H81 Integrated] @ edge I/O connectors - [MI987AF] : USB 3.0 x 4 ports - [MI987EF] : USB 3.0 x 2 ports
<b>Serial ATA</b>	Intel® Q87/ H81 PCH built-in SATA controller, - 2x SATA 3.0 (6Gbps) - 2 x mSATA [Q87 PCH Port 3/4 for SATA(3.0) or H81 PCH Port 3/4 for SATA(2.0)]
<b>Storage Device</b>	mSATA x 2 thru full-sized/half-sized Mini-PCIe socket @J12/J13 socket
<b>Audio</b>	Intel® Q87/H81 PCH built-in High Definition Audio controller + Realtek ALC662 w/ 5.1 channels
<b>LPC I/O</b>	Nuvoton NCT5523D (64-pin LQFP [7 mmx7 mm]) - COM #1 (RS232/422/485) support ring-in with power @500 mA (selectable for 5V or 12V) [EXAR SP339EER1 232/422/485 transceiver x 1 for jumper-less] - COM #2 (RS232 only) Hardware Monitor (2 thermal inputs,4 voltage monitor inputs & 2 Fan headers) - CPU FAN x 2 (PWM/DC type, 4-pin connector type, auto-detection by Nuvoton NCT3943S fan controller)
<b>Digital IO</b>	4 in & 4 out
<b>IAMT 9.0</b>	MI987AF only
<b>TPM 1.2</b>	Infineon SLB9655

<b>Expansion Slots</b>	- PCIe (4x) x1 [Gen 3.0 PEG] - MiniPCIe socket x 2 [ Full-sized + Half-sized stack type, Full-sized support PCIe/USB/mSATA, Half-sized support mSATA only] - Half-sized socket x 1 (3 <sup>rd</sup> Mini-PCIe@J16 , support PCIe / USB)
<b>Edge Connectors</b>	DC-Jack x 1 (C12135112DC102000P) DB9+DB15 stack connector for COM #1 + CRT DP + HDMI stack connector x 1 Dual USB (3.0) + RJ45 stack connector x 2 ** For MI987EF, USB 3.0 @ CN7 is USB2 only** Audio Jack 2 x 1 for MIC-in / Line-out **Reserved for 3-port connector population**
<b>Onboard Header/Connector</b>	2 ports x SATA III [Blue color] DF-11 2x4 pins pin-header x 3 for 6 ports USB 2.0 (MI987AF) DF-11 2x4 pins pin-header x 2 for 4 ports USB 2.0 (MI987EF) DF-11 2x6 pins pin-header x 1 for front panel audio DF-11 2x5 pins box header x 1 for COM2(RS232) 2x5 pins pin-header x1 for Digital IO 4 pins mini-type header for SATA device power x 2 [JST type] 2 x 4 pins pin header x 1 for front I/O (2.54 pitch)
<b>Watchdog Timer</b>	Yes (256 segments, 0, 1, 2...255 sec/min)
<b>System Voltage</b>	+19V DC-in ( Range = Min. +15.2V ~ Max. +22.8V) ** Supplemental voltage: +12V @ 8A max.; +5V @ 8A max. **
<b>Other</b>	- LAN Wakeup - EuP/ErP ( MI987EF only, thru Super I/O) - iSMART function(TI MSP430G2433 MCU) - Legacy Free from super I/O - AT24C02C EEPROM [SO8 type] via SMbus
<b>Board Size</b>	170mm x 170mm
<b>Operation System</b>	Windows 7, Windows 8/8.1
<b>Accessories (Optional)</b>	PK1H: C501PK1H009302000P (COM port cable) USB-29: C501USB2908303000P (USB Cable) AUDIO-34: C501AUD3410252000P (Audio Cable) SATA-17: C501SATA170253000P (SATA Cable)

**Board Dimensions**

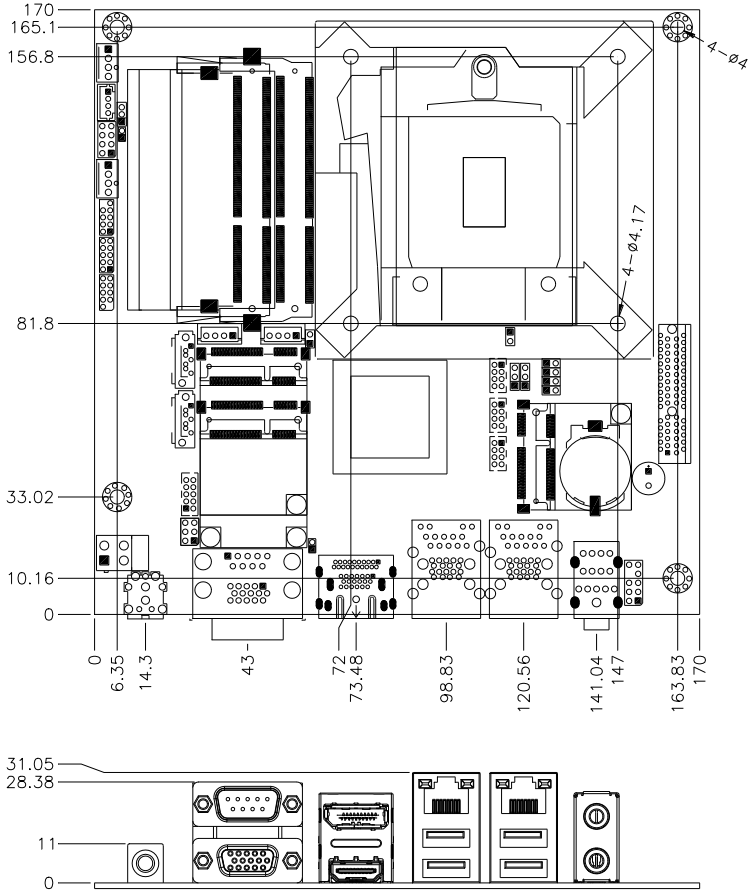



## **Installations**

This section provides information on how to use the jumpers and connectors on the MI987 in order to set up a workable system. The topics covered are:

Installing the Memory .....	6
Setting the Jumpers .....	7
Connectors on MI987 .....	12

### **Installing the Memory**

---

---

The MI987 board supports two DDR3 memory modules for a maximum total of 16GB in DDR3 SODIMM memory type.

#### **Installing and Removing Memory Modules**

To install the DDR3 modules, locate the memory slot on the board and perform the following steps:

1. Hold the DDR3 module so that the key of the DDR3 module aligned with that on the memory slot.
2. Gently push the DDR3 module in an upright position until the clips of the slot close to hold the DDR3 module in place when the DDR3 module touches the bottom of the slot.
3. To remove the DDR3 module, press the clips with both hands.

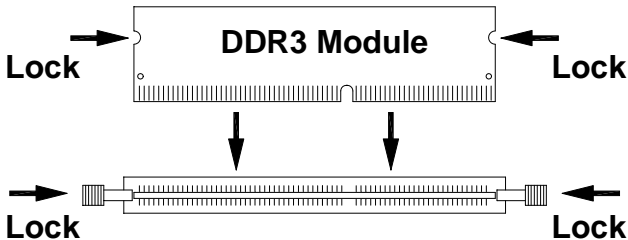

---

## **Setting the Jumpers**

---

---

Jumpers are used on MI987 to select various settings and features according to your needs and applications. Contact your supplier if you have doubts about the best configuration for your needs. The following lists the connectors on MI987 and their respective functions.

Jumper Locations on MI987 .....	8
JP1: COM1 RS232 RI/+5V/+12V Power Setting.....	9
JP8: Flash Descriptor Security Override (Factory use only).....	9
JBAT1: Clear CMOS Contents.....	10
J15: DP++ Select .....	10
JP10: Power On Type .....	11

**Jumper Locations on MI987**

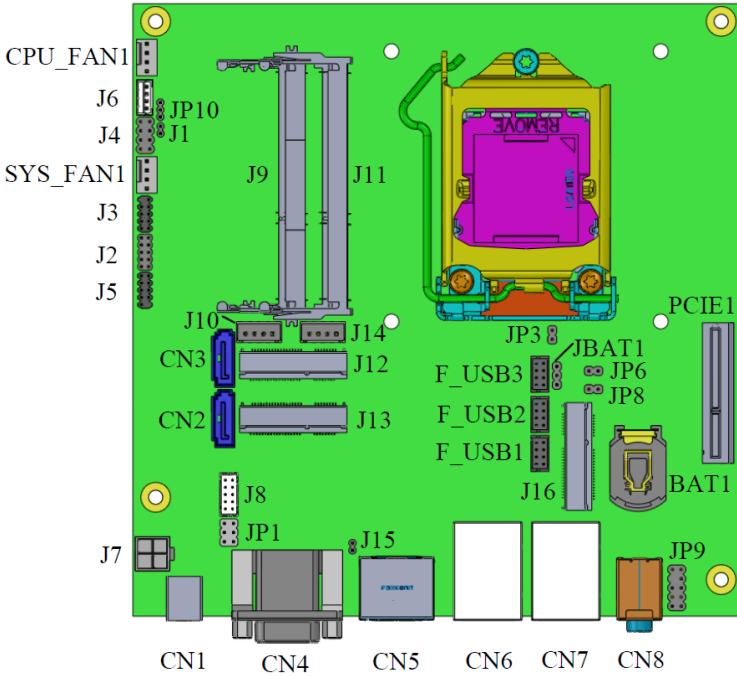

Jumpers on MI987 .....	Page
JP1: COM1 RS232 RI/+5V/+12V Power Setting .....	9
JP8: Flash Descriptor Security Override (Factory use only) .....	9
JBAT1: Clear CMOS Contents .....	10
J15: DP++ Select .....	10
JP10: Power On Type .....	11

**JP1: COM1 RS232 RI/+5V/+12V Power Setting**

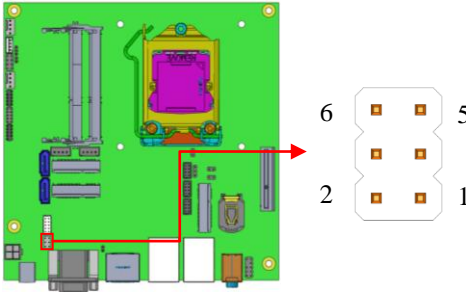

JP1(2.54mm)	Setting	Function
	Pin 1-3 Short/Closed	+12V(500mA)
	Pin 3-4 Short/Closed	RI
	Pin 3-5 Short/Closed	+5V(500mA)

**JP8: Flash Descriptor Security Override (Factory use only)**

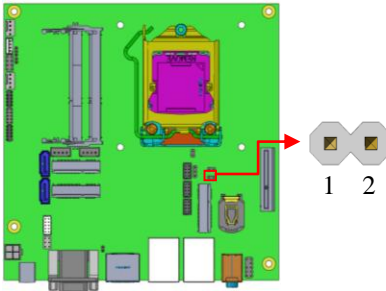

JP8 (2.54mm)	Flash Descriptor Security Override
Open	Disabled (Default)
Close	Enabled

## INSTALLATIONS

### JBAT1: Clear CMOS Contents

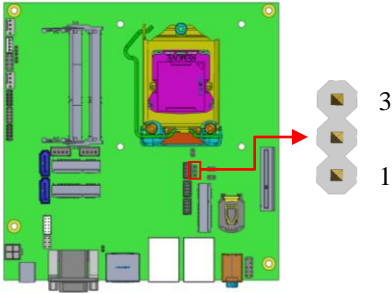

JBAT1(2.54mm)	Setting	Function
 1 2 3	Pin 1-2 Short/Closed	Normal
 1 2 3	Pin 2-3 Short/Closed	Clear CMOS

### J15: DP++ Select

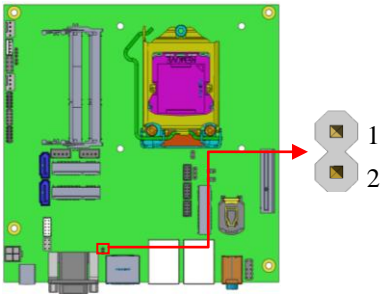

J15(2.0mm)	Function
Short	Display Port
Open	Dongle /DP to DVI / DP to HDMI

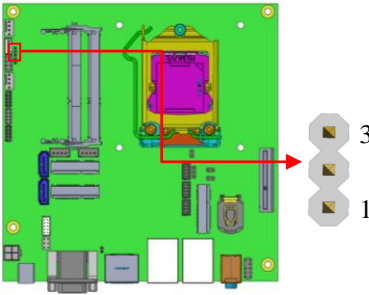
**JP10: Power On Type**

<b>JP10(2.0mm)</b>	<b>Function</b>
1-2	ATX Mode (Default)
2-3	AT Mode

---

---

**Connectors on MI987**

---

---

Connector Locations on MI987 .....	13
CN1: DC-IN Connector (+19V DC-in).....	14
CN4: CRT/COM1 Connector .....	14
CN5: DP/HDMI Connector .....	14
CN6: Gigabit LAN (Intel I217LM or I217V) / USB3.0 .....	14
CN7: Gigabit LAN (Intel I211AT) / USB3.0 (USB2.0 only for MI987EF version ) .....	14
CN8: Audio Connector .....	14
CN2, CN3: SATA3 Connectors .....	14
F_USB1/2/3: USB Connectors .....	15
J2: Digital I/O .....	15
J4: Front Panel Function Connector.....	16
J5: SPI Flash Connector (Factory use only).....	17
J6: MCU Flash Connector (factory use only).....	17
J7: DC-in Jack (19V) .....	17
J8: COM2 Connector .....	18
JP9: Audio Front Header .....	18
J10/J14: HDD Power Connector (Output Only) .....	19
J12: Mini PCIE/mSATA Connector .....	19
J13: mSATA Connector.....	19
J16: Mini PCIE Connector.....	20
PCIE1: PCIE_x4 Slot.....	20
CPU_FAN1: CPU Fan Power Connector .....	20
SYS_FAN1: System Fan1 Power Connector .....	21



**Connector Locations on MI987**

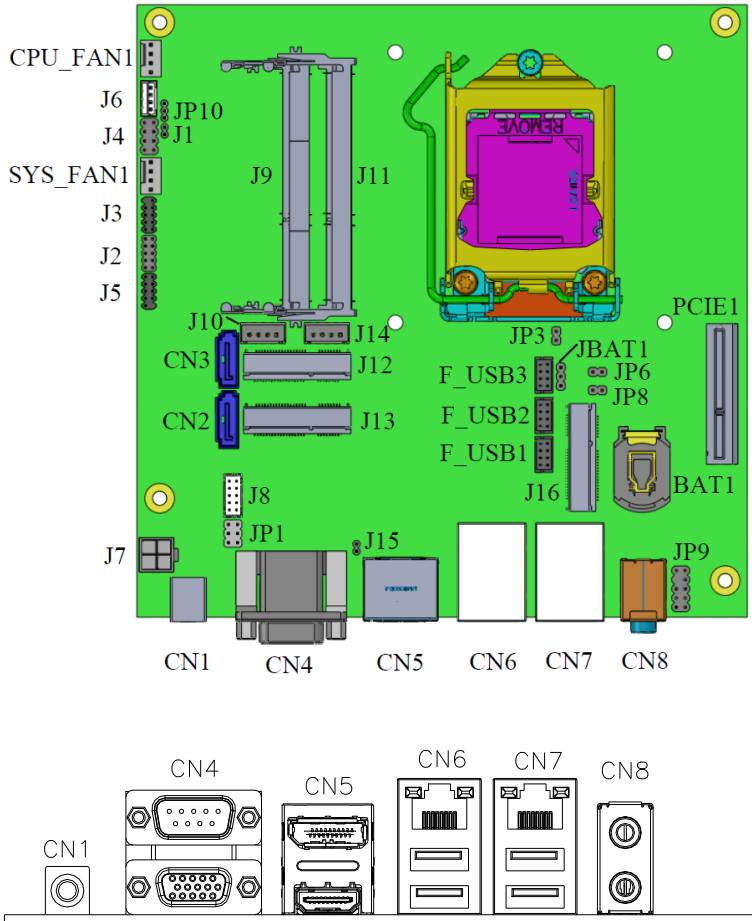

## INSTALLATIONS

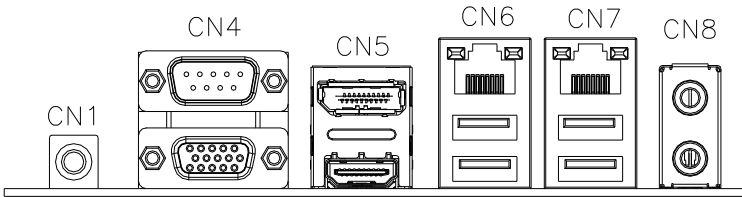

### CN1: DC-IN Connector

\*\*+19V DC-in Min+ 15.2V ~ Max +22.8V\*\*

### CN4: CRT/COM1 Connector

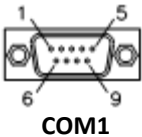

Pin #	Signal Name		
	RS-232	R2-422	RS-485
1	DCD	TX-	DATA-
2	RX	TX+	DATA+
3	TX	RX+	NC
4	DTR	RX-	NC
5	Ground	Ground	Ground
6	DSR	NC	NC
7	RTS	NC	NC
8	CTS	NC	NC
9	RI	NC	NC
10	NC	NC	NC

### CN5: DP/HDMI Connector

### CN6: Gigabit LAN (Intel I217LM or I217V) / USB3.0

### CN7: Gigabit LAN (Intel I211AT) / USB3.0

\*\*Support USB2.0 only for MI987EF version\*\*

### CN8: Audio Connector

### CN2, CN3: SATA3 Connectors

**F\_USB1/2/3: USB Connectors [HRS DF11-8DP-2DSA(08)]**

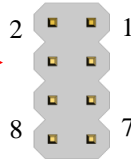
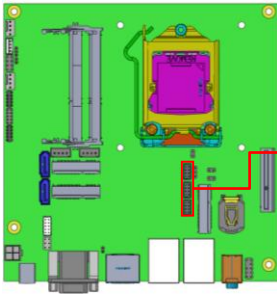

Signal Name	Pin #	Pin #	Signal Name
VCC	1	2	GND
D0-	3	4	D1+
D0+	5	6	D1-
GND	7	8	VCC

**J2: Digital I/O (2.0mm)**

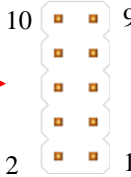
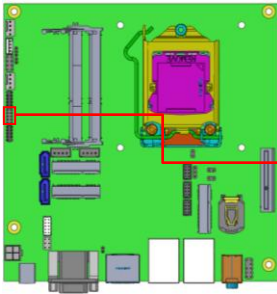

Signal Name	Pin #	Pin #	Signal Name
GND	1	2	VCC(500mA)
OUT3	3	4	OUT1
OUT2	5	6	OUT0
IN3	7	8	IN1
IN2	9	10	IN0

## J4: Front Panel Function Connector (2.54mm)

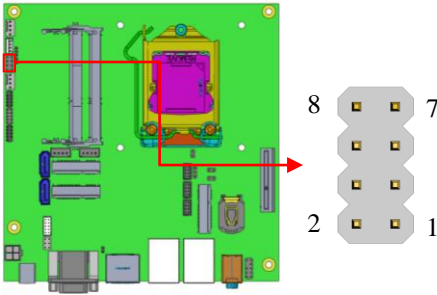

### 表格

#### ATX Power ON Switch: Pins 1 and 2

This 2-pin connector is an “ATX Power Supply On/Off Switch” on the system that connects to the power switch on the case. When pressed, the power switch will force the system to power on. When pressed again, it will force the system to power off.

#### Hard Disk Drive LED Connector: Pins 3 and 4

This connector connects to the hard drive activity LED on control panel. This LED will flash when the HDD is being accessed.

Pin #	Signal Name
4	HDD Active
3	3.3V

#### Reset Switch: Pins 5 and 6

The reset switch allows the user to reset the system without turning the main power switch off and then on again. Orientation is not required when making a connection to this header.

#### Power LED: Pins 7 and 8

Pin #	Signal Name
7	+5V
8	GND

**J5: SPI Flash Connector (Factory use only) [2.0mm]**

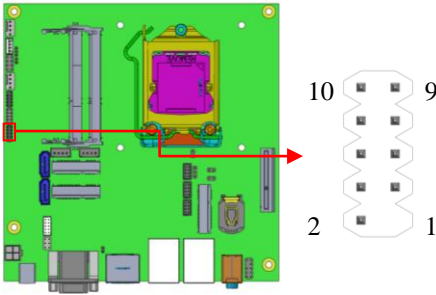

**J6: MCU Flash Connector (factory use only)**

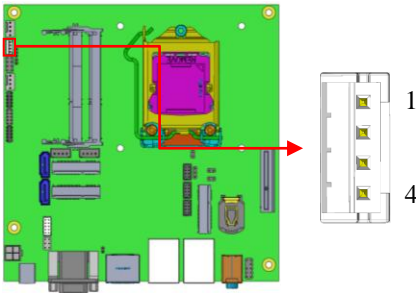

**J7: DC-in Jack (19V) [HAOGUO ATX4PT-NY46]**

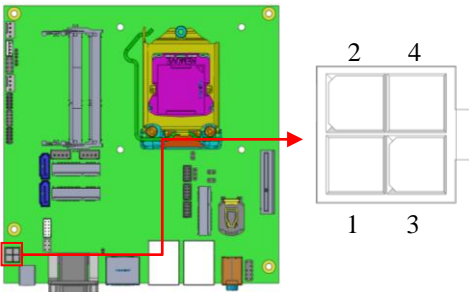

Pin #	Signal Name
1	Ground
2	Ground
3	DC_IN
4	DC_IN

## INSTALLATIONS

### J8: COM2 Connector [HRS DF11-10DP-2DSA(08)]

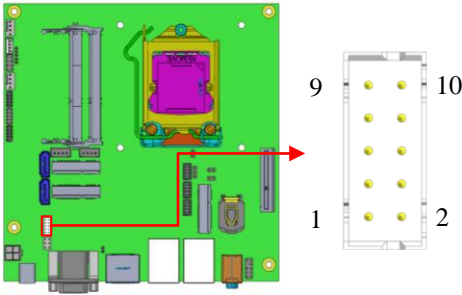

Signal Name	Pin #	Pin #	Signal Name
DCD, Data carrier detect	1	2	RXD, Receive data
TXD, Transmit data	3	4	DTR, Data terminal ready
GND, ground	5	6	DSR, Data set ready
RTS, Request to send	7	8	CTS, Clear to send
RI, Ring indicator	9	10	Not Used

### J9: Audio Front Header (2.54mm)

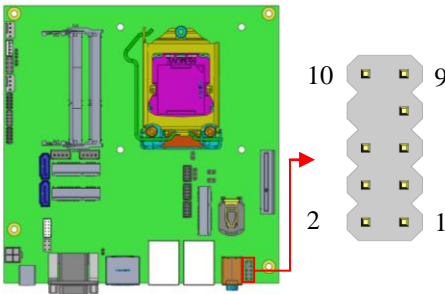

Signal Name	Pin #	Pin #	Signal Name
MIC2_L	1	2	Ground
MIC2_R	3	4	Presence#
Line2_R	5	6	MIC2_ID
Sense	7	8	NC
Line2_L	9	10	Line2_ID

**J10/J14: HDD Power Connector [E-CALL\_0110-071-040]**

**\*\*Output Only\*\***

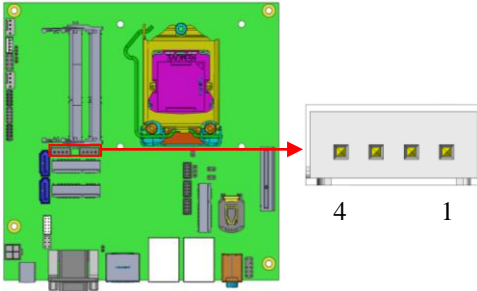

Pin #	Signal Name
1	+5V (2A)
2	Ground
3	Ground
4	+12V(1A)

**J12: Mini PCIE/mSATA Connector**

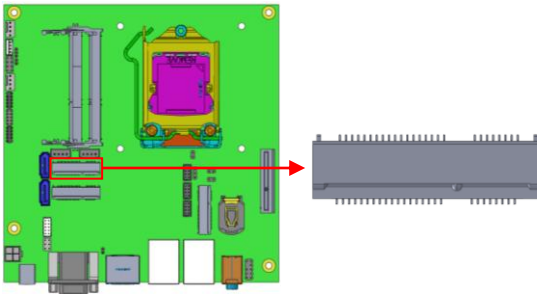

**J13: mSATA Connector**

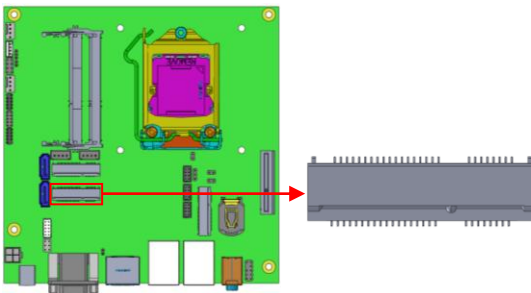

## J16: Mini PCIE Connector

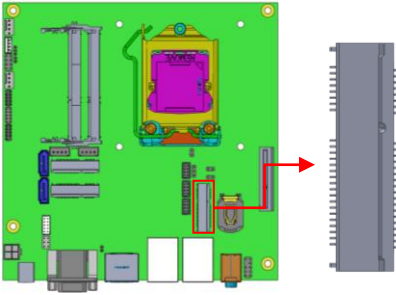

## PCIE1: PCIE\_x4 Slot

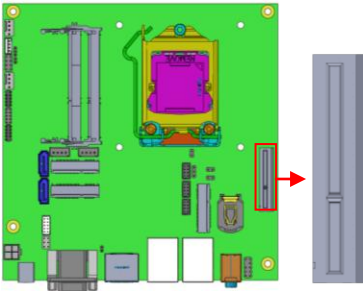

## CPU\_FAN1: CPU Fan Power Connector

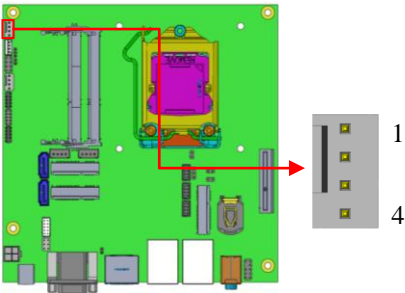

Pin #	Signal Name
1	Ground
2	+12V(1A)
3	Rotation detection
4	Control

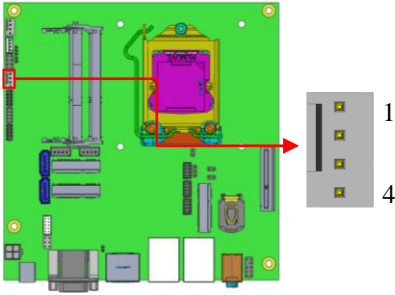

**SYS\_FAN1: System Fan1 Power Connector**

Pin #	Signal Name
1	Ground
2	+12V(1A)
3	Rotation detection
4	Control

This page is intentionally left blank.

# BIOS Setup

This chapter describes the different settings available in the AMI BIOS that comes with the board. The topics covered in this chapter are as follows:

BIOS Introduction .....	24
BIOS Setup .....	24
Advanced Settings .....	26
Chipset Settings .....	36
Boot Settings .....	41
CSM parameters .....	42
Security Settings .....	43
Save & Exit Settings .....	44

### **BIOS Introduction**

The BIOS (Basic Input/Output System) installed in your computer system's ROM supports Intel processors. The BIOS provides critical low-level support for a standard device such as disk drives, serial ports and parallel ports. It also provides password protection as well as special support for detailed fine-tuning of the chipset controlling the entire system.

### **BIOS Setup**

The BIOS provides a Setup utility program for specifying the system configurations and settings. The BIOS ROM of the system stores the Setup utility. When you turn on the computer, the BIOS is immediately activated. Pressing the <Del> key immediately allows you to enter the Setup utility. If you are a little bit late pressing the <Del> key, POST (Power On Self Test) will continue with its test routines, thus preventing you from invoking the Setup. If you still wish to enter Setup, restart the system by pressing the "Reset" button or simultaneously pressing the <Ctrl>, <Alt> and <Delete> keys. You can also restart by turning the system Off and back On again. The following message will appear on the screen:

Press <DEL> to Enter Setup

In general, you press the arrow keys to highlight items, <Enter> to select, the <PgUp> and <PgDn> keys to change entries, <F1> for help and <Esc> to quit.

When you enter the Setup utility, the Main Menu screen will appear on the screen. The Main Menu allows you to select from various setup functions and exit choices.

**Warning:** *It is strongly recommended that you avoid making any changes to the chipset defaults. These defaults have been carefully chosen by both AMI and your system manufacturer to provide the absolute maximum performance and reliability. Changing the defaults could cause the system to become unstable and crash in some cases.*

**Main Settings**

Aptio Setup Utility – Copyright © 2012 American Megatrends, Inc.

Main	Advanced	Chipset	Boot	Security	Save & Exit
Total Memory			16384 (DDR3)		→ ← Select Screen ↑ ↓ Select Item Enter: Select +- Change Opt. F1: General Help F2: Previous Values F3: Optimized Defaults F4: Save & Exit ESC: Exit
Memory Frequency			1333 Mhz		
System Date			[Wed 10/30/2013]		
System Time			[21:52:06]		

**System Date**

Set the Date. Use Tab to switch between Date elements.

**System Time**

Set the Time. Use Tab to switch between Time elements.

## Advanced Settings

This section allows you to configure and improve your system and allows you to set up some system features according to your preference.

Aptio Setup Utility – Copyright © 2012 American Megatrends, Inc.

Main	Advanced	Chipset	Boot	Security	Save & Exit
	<ul style="list-style-type: none"> <li>▶ PCI Subsystem Settings</li> <li>▶ ACPI Settings</li> <li>▶ Trusted Computing</li> <li>▶ Wakeup event Configuration</li> <li>▶ CPU Configuration</li> <li>▶ SATA Configuration</li> <li>▶ Shutdown Temperature Configuration</li> <li>▶ iSmart Controller</li> <li>▶ AMT Configuration</li> <li>▶ USB Configuration</li> <li>▶ NCT5523D Super IO Configuration</li> <li>▶ NCT5523D H/W Monitor</li> </ul>				→ ← Select Screen ↑ ↓ Select Item Enter: Select +- Change Opt. F1: General Help F2: Previous Values F3: Optimized Defaults F4: Save & Exit ESC: Exit

## PCI Subsystem Settings

Aptio Setup Utility – Copyright © 2012 American Megatrends, Inc.

Main	Advanced	Chipset	Boot	Security	Save & Exit
	PCI Bus Driver Version		V 2.05.02		→ ← Select Screen ↑ ↓ Select Item Enter: Select +- Change Opt. F1: General Help F2: Previous Values F3: Optimized Defaults F4: Save & Exit ESC: Exit
	PCI Common Settings				
	PCI Latency Timer		32 PCI Bus Clocks		
	VGA Palette Snoop		Disabled		
	PERR# Generation		Disabled		
	SERR# Generation		Disabled		

### PCI Latency Timer

Value to be programmed into PCI Latency Timer Register.

### VGA Palette Snoop

Enables or disables VGA Palette Registers Snooping.

### PERR# Generation

Enables or disables PCI device to generate PERR#.

### SERR# Generation

Enables or disables PCI device to generate SERR#.

**ACPI Settings**

Aptio Setup Utility – Copyright © 2012 American Megatrends, Inc.

Main	Advanced	Chipset	Boot	Security	Save & Exit
ACPI Settings					→ ← Select Screen ↑ ↓ Select Item Enter: Select +- Change Opt. F1: General Help F2: Previous Values F3: Optimized Defaults F4: Save & Exit ESC: Exit
Enable ACPI Auto Configuration		Disabled			
Enable Hibernation		Enabled			
ACPI Sleep State		S3 only (Suspend to ...)			
Lock Legacy Resources		Disabled			
S3 Video Repost		Disabled			

**Enabled ACPI Auto Configuration**

Enables or Disables BIOS ACPI Auto Configuration.

**Enable Hibernation**

Enables or Disables System ability to Hibernate (OS/S4 Sleep State). This option may be not effective with some OS.

**ACPI Sleep State**

Select ACPI sleep state the system will enter when the SUSPEND button is pressed.

**Lock Legacy Resources**

Enables or Disables Lock of Legacy Resources.

**S3 Video Repost**

Enable or Disable S3 Video Repost.

**Trusted Computing**

Aptio Setup Utility - Copyright © 2012 American Megatrends, Inc.

Main	Advanced	Chipset	Boot	Security	Save & Exit
Configuration					
	Security Device Support		Disabled		→ ← Select Screen ↑ ↓ Select Item Enter: Select +- Change Opt. F1: General Help F2: Previous Values F3: Optimized Defaults F4: Save & Exit ESC: Exit
Current Status Information					
	SUPPORT TURNED OFF				

**Security Device Support**

This configuration is supported only with MI987AF. Enables or disables BIOS support for security device. O.S. will not show Security Device. TCG EFI protocol and INT1A interface will not be available.

**TPM State**

Enable/Disable Security Device. NOTE: Your Computer will reboot during restart in order to change State of the Device.

**Pending operation**

Schedule an Operation for the Security Device. NOTE: Your Computer will reboot during restart in order to change State of Security Device.

**Wake up event settings**

Aptio Setup Utility - Copyright © 2012 American Megatrends, Inc.

Main	Advanced	Chipset	Boot	Security	Save & Exit
	Wake on Ring		Disabled		→ ← Select Screen ↑ ↓ Select Item Enter: Select +- Change Opt. F1: General Help F2: Previous Values F3: Optimized Defaults F4: Save & Exit ESC: Exit
	Wake on PCIE Wake Event		Enabled		

**Wake up by Ring / Wake up by PCIE WAKE#**

The options are Disabled and Enabled.



**CPU Configuration**

This section shows the CPU configuration parameters.

Aptio Setup Utility - Copyright © 2012 American Megatrends, Inc.

Main	Advanced	Chipset	Boot	Security	Save & Exit
CPU Configuration					
Intel(R) Core(TM) i5-4570S CPU @ 2.90GHz					
CPU Signature			306c3		
Processor Family			6		
Microcode Patch			16		
FSB Speed			100 MHz		
Max CPU Speed			2900 MHz		
Min CPU Speed			800 MHz		
CPU Speed			2900 MHz		
Processor Cores			4		
Intel HT Technology			Not Supported		
Intel VT-x Technology			Supported		
Intel SMX Technology			Supported		
64-bit			Supported		
EIST Technology			Supported		
Active Processor Cores			All		
Limit CPUID Maximum			Disabled		
Execute Disable Bit			Enabled		
Intel Virtualization Technology			Enabled		
Boot performance mode			Turbo Performance		
EIST			Enabled		
Intel TXT(LT) Support			Disabled		
					→ ← Select Screen ↑ ↓ Select Item Enter: Select +- Change Opt. F1: General Help F2: Previous Values F3: Optimized Defaults F4: Save & Exit ESC: Exit

**Active Processor Cores**

Number of cores to enable in each processor package.

**Execute Disable Bit**

XD can prevent certain classes of malicious buffer overflow attacks when combined with a supporting OS (Windows Server 2003 SP1, SuSE Linux 9.2, RedHat Enterprise 3 Update 3.)

**Intel Virtualization Technology**

When enabled, a VMM can utilize the additional hardware capabilities provided by Vanderpool Technology.

## BIOS SETUP

### Boot performance mode

Select the performance state that the BIOS will set before OS handoff.

### EIST

Enable/Disable Intel Speedstep

### Intel TXT(LT) Support

Enables or Disables Intel (R)TXT (LT) Support.

### SATA Configuration

SATA Devices Configuration.

Aptio Setup Utility – Copyright © 2012 American Megatrends, Inc.

Main	Advanced	Chipset	Boot	Security	Save & Exit
	SATA Controller(s)	Enabled			
	SATA Mode Selection	AHCI			
	SATA Controller Speed	Default			
	SATA Port0	Empty			→ ← Select Screen
	Software Preserve	Unknown			↑ ↓ Select Item
	Hot Plug	Disabled			Enter: Select
	SATA Port1	Empty			+ - Change Opt.
	Software Preserve	Unknown			F1: General Help
	Hot Plug	Disabled			F2: Previous Values
	SATA Port4	Empty			F3: Optimized Defaults
	Software Preserve	Unknown			F4: Save & Exit
	Hot Plug	Disabled			ESC: Exit

### SATA Controller(s)

Enable or disable SATA Device.

### SATA Mode Selection

Determines how SATA controller(s) operate.

- (1) IDE Mode.
- (2) AHCI Mode.
- (3) RAID Mode. (MI987AF only)

### SATA Controller Speed

Indicates the maximum speed the SATA controller can support.

### Hot Plug

Designates this port as Hot Pluggable.

**Shutdown Temperature Configuration**

Aptio Setup Utility – Copyright © 2012 American Megatrends, Inc.

Main	Advanced	Chipset	Boot	Security	Save & Exit
ACPI Shutdown Temperature			Disabled		→ ← Select Screen ↑ ↓ Select Item Enter: Select +- Change Opt. F1: General Help F2: Previous Values F3: Optimized Defaults F4: Save & Exit ESC: Exit

**ACPI Shutdown Temperature**

The default setting is Disabled .

**iSmart Controller**

Aptio Setup Utility – Copyright © 2012 American Megatrends, Inc.

Main	Advanced	Chipset	Boot	Security	Save & Exit
iSmart Controller					→ ← Select Screen ↑ ↓ Select Item Enter: Select +- Change Opt. F1: General Help F2: Previous Values F3: Optimized Defaults F4: Save & Exit ESC: Exit
Eup/Erp standby power control			Keep standby power		
Power-On after Power failure			Disable		
Schedule Slot 1			None		
Schedule Slot 2			None		

**Eup/Erp standby power control**

This configuration is supported only with MI987EF. Eup/Erp control on S5[Keep standby power] Enable all of the standby power and ignore Eup/Erp specification .[Ethernet Only] Only provide the standby power for Ethernet chip.[Disabled] Shutdown all of the standby power.

**Power-On after Power failure**

This field sets the system power status whether *Disable* or *Enable* when power returns to the system from a power failure situation.

**Schedule Slot 1 / 2**

Setup the hour/minute for system power on.

**AMT Configuration**

Aptio Setup Utility - Copyright © 2012 American Megatrends, Inc.

Main	Advanced	Chipset	Boot	Security	Save & Exit
			Intel AMT	Enabled	
			BIOS Hotkey Pressed	Disabled	
			MEBx Selection Screen	Disabled	
			Hide Un-Configure ME Confirmation	Disabled	→ ← Select Screen
			Un-Configure ME	Disabled	↑ ↓ Select Item
			Amt Wait Timer	0	Enter: Select
			Activate Remote Assistance Process	Disabled	+ - Change Opt.
			USB Configure	Enabled	F1: General Help
			PET Progress	Enabled	F2: Previous Values
			AMT CIRA Timeout	0	F3: Optimized Defaults
			Watchdog	Disabled	F4: Save & Exit
			OS Timer	0	ESC: Exit
			BIOS Timer	0	

AMT configuration is supported only with MI987AF (with iAMT function).

**Intel AMT**

Enable/Disable Intel (R) Active Management Technology BIOS Extension.

Note: iAMT H/W is always enabled. This option just controls the BIOS extension execution. If enabled, this requires additional firmware in the SPI device.

**BIOS Hotkey Pressed**

OEMFLag Bit 1: Enable/Disable BIOS hotkey press.

**AMT Configuration**

OEMFLag Bit 2: Enable/Disable MEBx selection screen.

**Hide Un-Configure ME Configuration**

OEMFLag Bit 6: Hide Un-Configure ME without password Confirmation Prompt.

**Un-Configure ME**

OEMFLag Bit 15: Un-Configure ME without password.

**Amt Wait Timer**

Set timer to wait before sending ASF\_GET\_BOOT\_OPTIONS.

**Activate Remote Assistance Process**

Trigger CIRA boot.

**USB Configure**

Enable/Disable USB Configure function.

**PET Progress**

User can Enable/Disable PET Events progress to receive PET events or not.

**Watchdog Timer**

Enable/Disable Watchdog Timer.

**USB Configuration**

Aptio Setup Utility - Copyright © 2012 American Megatrends, Inc.

Main	Advanced	Chipset	Boot	Security	Save & Exit
USB Configuration					
USB Module Version		8.10.28			
USB Devices:					
2 Keyboards, 1 Mouse, 2 Hubs					
Legacy USB Support		Enabled		→ ← Select Screen	
USB3.0 Support		Enabled		↑ ↓ Select Item	
XHCI Hand-off		Enabled		Enter: Select	
EHCI Hand-off		Enabled		+- Change Opt.	
USB Mass Storage Driver Support		Enabled		F1: General Help	
USB hardware delays and time-outs:					F2: Previous Values
USB Transfer time-out		20 sec		F3: Optimized Defaults	
Device reset time-out		20 sec		F4: Save & Exit	
Device power-up delay		Auto		ESC: Exit	

**Legacy USB Support**

Enables Legacy USB support.

AUTO option disables legacy support if no USB devices are connected. DISABLE option will keep USB devices available only for EFI applications.

**USB3.0 Support**

Enable/Disable USB3.0 (XHCI) Controller support.

### XHCI Hand-off

This is a workaround for OSES without XHCI hand-off support. The XHCI ownership change should be claimed by XHCI driver.

### EHCI Hand-off

This is a workaround for OSES without EHCI hand-off support. The XHCI ownership change should be claimed by EHCI driver.

### USB Mass Storage Driver Support

Enable/Disable USB Mass Storage Driver Support.

### USB Transfer time-out

The time-out value for Control, Bulk, and Interrupt transfers.

### Device reset time-out

USB mass Storage device start Unit command time-out.

### Device power-up delay

Maximum time the device will take before it properly reports itself to the Host Controller. 'Auto' uses default value: for a Root port it is 100ms, for a Hub port the delay is taken from Hub descriptor.

## NCT5523D Super IO Configuration

Aptio Setup Utility - Copyright © 2012 American Megatrends, Inc.

Main	Advanced	Chipset	Boot	Security	Save & Exit
NCT5523D Super IO Configuration					
NCT5523D Super IO Chip		NCT5523D			
▶ Serial Port 0 Configuration					
▶ Serial Port 1 Configuration					
					→ ← Select Screen ↑ ↓ Select Item Enter: Select +- Change Opt.. F1: General Help F2: Previous Values F3: Optimized Defaults F4: Save & Exit ESC: Exit

### Serial Port Configuration

Set Parameters of Serial Ports. User can Enable/Disable the serial port and Select an optimal settings for the Super IO Device.

**NCT5523D H/W Monitor**

Aptio Setup Utility - Copyright © 2012 American Megatrends, Inc.

Main	Advanced	Chipset	Boot	Security	Save & Exit
PC Health Status					
Smart SYS_FAN1 Function		Disabled			
Smart CPU_FAN1 Function		Disabled			
SYS temp		+33.0 C			→ ← Select Screen
CPU temp		+34.5 C			↑ ↓ Select Item
SYS_FAN1 Speed		4066 RPM			Enter: Select
CPU_FAN1 Speed		4066 RPM			+ - Change Opt.
Vcore		+1.704 V			F1: General Help
+1.5V		+1.544 V			F2: Previous Values
AVCC		+3.360 V			F3: Optimized Defaults
VSB3		+3.344 V			F4: Save & Exit
					ESC: Exit

**Smart SYS\_FAN1/CPU\_FAN1 Function**

This field enables or disables the smart fan feature.

Disabled (default)

50 °C

60 °C

70 °C

80 °C

90 °C

**Temperatures/Voltages**

These fields are the parameters of the hardware monitoring function feature of the motherboard. The values are read-only values as monitored by the system and show the PC health status.

## Chipset Settings

This section allows you to configure and improve your system and allows you to set up some system features according to your preference.

Aptio Setup Utility - Copyright © 2012 American Megatrends, Inc.

Main	Advanced	Chipset	Boot	Security	Save & Exit
		<ul style="list-style-type: none"> <li>▶ PCH-IO Configuration</li> <li>▶ System Agent (SA) Configuration</li> </ul>			→ ← Select Screen ↑ ↓ Select Item Enter: Select +- Change Opt. F1: General Help F2: Previous Values F3: Optimized Defaults F4: Save & Exit ESC: Exit

## PCH-IO Configuration

This section allows you to configure the North Bridge Chipset.

Aptio Setup Utility - Copyright © 2012 American Megatrends, Inc.

Main	Advanced	Chipset	Boot	Security	Save & Exit
		Intel PCH RC Version	1.6.2.0		→ ← Select Screen ↑ ↓ Select Item Enter: Select +- Change Opt. F1: General Help F2: Previous Values F3: Optimized Defaults F4: Save & Exit ESC: Exit
		Intel PCH SKU Name	Q87		
		Intel PCH Rev ID	05/C2		
		<ul style="list-style-type: none"> <li>▶ PCI Express Configuration</li> <li>▶ PCH Azalia Configuration</li> </ul>			
		PCH LAN Controller	Enabled		
		Wake on LAN	Enabled		
		SLP_S4 Assertion Width	4-5 Seconds		

## PCH LAN Controller

Enable or disable onboard NIC.

## Wake on LAN

Enable or disable integrated LAN to wake the system. (The Wake On LAN cannot be disabled if ME is on at Sx state.)

## SLP\_S4 Assertion Width

Select a minimum assertion width of the SLP\_S4# signal.



**PCI Express Configuration**

Aptio Setup Utility – Copyright © 2012 American Megatrends, Inc.

Main	Advanced	Chipset	Boot	Security	Save & Exit
PCI Express Configuration					
		PCI Express Clock Gating	Enabled		
		DMI Link ASPM Control	Disabled		
		DMI Link Extended Synch Control	Disabled		
		PCIe-USB Glitch W/A	Disabled		
		Subtractive Decode	Disabled		
		▶ PCI Express Root Port 1			→ ← Select Screen ↑ ↓ Select Item Enter: Select +- Change Opt. F1: General Help F2: Previous Values F3: Optimized Defaults F4: Save & Exit ESC: Exit
		▶ PCI Express Root Port 2			
		▶ PCI Express Root Port 3			
		▶ PCI Express Root Port 4			
		▶ PCI Express Root Port 5			
		PCI-E Port 6 is assigned to LAN			
		▶ PCI Express Root Port 7			
		▶ PCI Express Root Port 8			

**PCI Express Clock Gating**

Enable or disable PCI Express Clock Gating for each root port.

**DMI Link ASPM Control**

The control of Active State Power Management on both NB side and SB side of the DMI Link.

**DMI Link Extended Synch Control**

The control of Extended Synch on SB side of the DMI Link.

**PCIe-USB Glitch W/A**

PCIe-USB Glitch W/A for bad USB device(s) connected behind PCIE/PEG port.

**Subtractive Decode**

Enable or disable PCI Express Subtractive Decode.

**PCH Azalia Configuration**

Aptio Setup Utility - Copyright © 2012 American Megatrends, Inc.

Main	Advanced	Chipset	Boot	Security	Save & Exit
PCH Azalia Configuration					→ ← Select Screen
Azalia					↑ ↓ Select Item
Azalia Docking Support					Enter: Select
Azalia PME					+ - Change Opt.
					F1: General Help
					F2: Previous Values
					F3: Optimized Defaults
					F4: Save & Exit
					ESC: Exit

**Azalia**

Control Detection of the Azalia device.

Disabled = Azalia will be unconditionally disabled.

Enabled Azalia will be unconditionally Enabled .

Auto = Azalia will be enabled if present, disabled otherwise.

**Azalia Docking Support**

Enable or disable Azalia Docking Support of Audio Controller.

**Azalia PME**

Enable or disable Power Management capability of Audio Controller.

**System Agent (SA) Configuration**

Aptio Setup Utility - Copyright © 2012 American Megatrends, Inc.

Main	Advanced	Chipset	Boot	Security	Save & Exit
		System Agent Bridge Name	Haswell		→ ← Select Screen ↑ ↓ Select Item Enter: Select +- Change Opt. F1: General Help F2: Previous Values F3: Optimized Defaults F4: Save & Exit ESC: Exit
		System Agent RC Version	1.6.2.0		
		VT-d Capability	Supported		
		VT-d	Enabled		
		▶ Graphics Configuration			

**VT-d**

Check to enable VT-d function on MCH.

**Graphics Configuration**

Aptio Setup Utility - Copyright © 2012 American Megatrends, Inc.

Main	Advanced	Chipset	Boot	Security	Save & Exit
		Graphics Configuration			→ ← Select Screen ↑ ↓ Select Item Enter: Select +- Change Opt. F1: General Help F2: Previous Values F3: Optimized Defaults F4: Save & Exit ESC: Exit
		IGFX VBIOS Version	2170		
		IGfx Frequency	700 MHz		
		Primary Display	Auto		
		Primary PEG	Auto		
		Primary PCIE	Auto		
		Internal Graphics	Auto		
		Aperture Size	256MB		
		DVMT Pre-Allocated	32M		
		DVMT Total Gfx Mem	256MB		
		Gfx Low Power Mode	Enabled		

**Primary Display**

Select which of IGFX/PEG/PCI graphics device should be Primary Display or select SG for switchable Gfx.

**Primary PEG**

Select PEG0/PEG1/PEG2/PEG3 Graphics device should be Primary PEG.

## **BIOS SETUP**

---

### **Primary PCIE**

Select PCIE0/PCIE1/PCIE2/PCIE3/PCIE4/PCIE5/PCIE6/PCIE7  
Graphics device should be Primary PCIE.

### **Internal Graphics**

Keep IGD enabled based on the setup options.

### **Aperture Size**

Select the Aperture Size.

### **DVMT Pre-Allocated**

Select DVMT 5.0 Pre-Allocated (Fixed) Graphics Memory Size used by  
the Internal Graphics Device.

### **DVMT Total Gfx Mem**

Select DVMT 5.0 Total Graphics Memory Size used by the Internal  
Graphics Device.

### **Gfx Low Power Mode**

This option is applicable for SFF only.

## Boot Settings

This section allows you to configure the boot settings.

Aptio Setup Utility - Copyright © 2012 American Megatrends, Inc.

Main	Advanced	Chipset	Boot	Security	Save & Exit
Boot Configuration					
	Setup Prompt Timeout		1		
	Bootup NumLock State		On		→ ← Select Screen ↑ ↓ Select Item Enter: Select +- Change Opt. F1: General Help F2: Previous Values F3: Optimized Defaults F4: Save & Exit ESC: Exit
	Quiet Boot		Disabled		
	Fast Boot		Disabled		
	Boot Option Priorities				
	▶ CSM16 parameters				
	CSM parameters				

### Setup Prompt Timeout

Number of seconds to wait for setup activation key.  
65535(0xFFFF) means indefinite waiting.

### Bootup NumLock State

Select the keyboard NumLock state.

### Quiet Boot

Enables or disables Quiet Boot option.

### Fast Boot

Enables or disables boot with initialization of a minimal set of devices required to launch active boot option. Has no effect for BBS boot options.

### Boot Option Priorities

Sets the system boot order.

**CSM parameters**

This section allows you to configure the boot settings.

Aptio Setup Utility - Copyright © 2012 American Megatrends, Inc.

Main	Advanced	Chipset	Boot	Security	Save & Exit
Launch CSM			Enabled		→ ← Select Screen
Boot option filter			UEFI and Legacy		↑ ↓ Select Item
Launch PXE OpROM policy			Do not launch		Enter: Select
Launch Storage OpROM policy			Legacy only		+ - Change Opt.
Launch Video OpROM policy			Legacy only		F1: General Help
					F2: Previous Values
					F3: Optimized Defaults
					F4: Save & Exit
Other PCI device ROM priority			Legacy OpROM		ESC: Exit

**Launch CSM**

This option controls if CSM will be launched.

**Boot option filter**

This option controls what devices system can boot to.

**Launch PXE OpROM policy**

Controls the execution of UEFI and Legacy PXE OpROM.

**Launch Storage OpROM policy**

Controls the execution of UEFI and Legacy Storage OpROM.

**Launch Video OpROM policy**

Controls the execution of UEFI and Legacy Video OpROM.

**Other PCI device ROM priority**

For PCI devices other than Network, Mass storage or Video defines which OpROM to launch.

## Security Settings

This section allows you to configure and improve your system and allows you to set up some system features according to your preference.

Aptio Setup Utility – Copyright © 2012 American Megatrends, Inc.

Main	Advanced	Chipset	Boot	Security	Save & Exit				
Password Description  If ONLY the Administrator's password is set, then this only limit access to Setup and is only asked for when entering Setup. If ONLY the User's password is set, then this is a power on password and must be entered to boot or enter Setup. In Setup the User will have Administrator rights The password length must be in the following range: <table> <tr> <td>Minimum length</td> <td>3</td> </tr> <tr> <td>Maximum length</td> <td>20</td> </tr> </table>					Minimum length	3	Maximum length	20	→ ← Select Screen ↑ ↓ Select Item Enter: Select +- Change Opt. F1: General Help F2: Previous Values F3: Optimized Defaults F4: Save & Exit ESC: Exit
Minimum length	3								
Maximum length	20								
Administrator Password									

### Administrator Password

Set Administrator Password.

**Save & Exit Settings**

Aptio Setup Utility - Copyright © 2012 American Megatrends, Inc.

Main	Advanced	Chipset	Boot	Security	Save & Exit
Save Changes and Exit					
Discard Changes and Exit					
Save Changes and Reset					
Discard Changes and Reset					
Save Options					→ ← Select Screen
Save Changes					↑ ↓ Select Item
Discard Changes					Enter: Select
					+ - Change Opt.
					F1: General Help
					F2: Previous Values
					F3: Optimized Defaults
					F4: Save & Exit
					ESC: Exit
Restore Defaults					
Save as User Defaults					
Restore User Defaults					

**Save Changes and Exit**

Exit system setup after saving the changes.

**Discard Changes and Exit**

Exit system setup without saving any changes.

**Save Changes and Reset**

Reset the system after saving the changes.

**Discard Changes and Reset**

Reset system setup without saving any changes.

**Save Changes**

Save Changes done so far to any of the setup options.

**Discard Changes**

Discard Changes done so far to any of the setup options.

**Restore Defaults**

Restore/Load Defaults values for all the setup options.

**Save as User Defaults**

Save the changes done so far as User Defaults.

**Restore User Defaults**

Restore the User Defaults to all the setup options.



## Drivers Installation

This section describes the installation procedures for software and drivers. The software and drivers are included with the motherboard. If you find the items missing, please contact the vendor where you made the purchase. The contents of this section include the following:

Intel Chipset Software Installation Utility .....	46
VGA Drivers Installation .....	47
Realtek HD Audio Driver Installation .....	48
LAN Drivers Installation .....	49
Intel® Management Engine Interface .....	50
Intel® USB 3.0 Drivers .....	51

### **IMPORTANT NOTE:**

After installing your Windows operating system, you must install first the Intel Chipset Software Installation Utility before proceeding with the drivers installation.

# Intel Chipset Software Installation Utility

---

---

The Intel Chipset Drivers should be installed first before the software drivers to enable Plug & Play INF support for Intel chipset components. Follow the instructions below to complete the installation.

1. Insert the DVD that comes with the board. Click **Intel** and then **Intel(R) 8 Series Chipset Drivers**.



2. Click **Intel(R) Chipset Software Installation Utility**.



3. When the Welcome screen to the Intel® Chipset Device Software appears, click **Next** to continue.
4. Click **Yes** to accept the software license agreement and proceed with the installation process.
5. On the Readme File Information screen, click **Next** to continue the installation.
6. The Setup process is now complete. Click **Finish** to restart the computer and for changes to take effect.

## VGA Drivers Installation

1. Insert the DVD that comes with the board. Click *Intel* and then *Intel(R) 8 Series Chipset Drivers*. Click *Intel(R) Graphics Driver*.



2. When the Welcome screen appears, click *Next* to continue.
3. Click *Yes* to agree with the license agreement and continue the installation.
4. On the Readme File Information screen, click *Next* to continue the installation of the Intel® HD Graphics Driver.
5. On the screen shown below, click *Install* to continue.

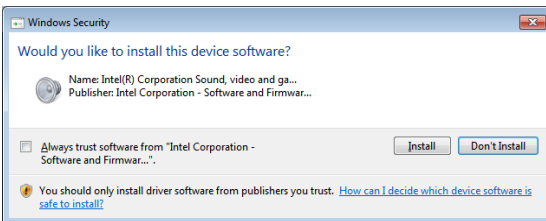
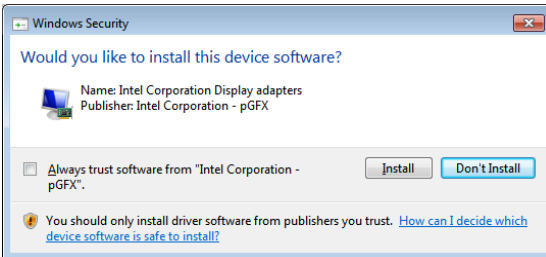

6. On the Setup Progress screen, click *Next* to continue.
7. Setup complete. Click *Finish* to restart the computer and for changes to take effect.

## **Realtek HD Audio Driver Installation**

---

1. Insert the DVD that comes with the board. Click *Intel* and then *Intel(R) 8 Series Chipset Drivers*. Click *Realtek High Definition Audio Driver*.



2. On the Welcome to the InstallShield Wizard screen, click *Next* to proceed with and complete the installation process.

3. The InstallShield Wizard Complete. Click *Finish* to restart the computer and for changes to take effect.

## LAN Drivers Installation

1. Insert the DVD that comes with the board. Click **Intel** and then **Intel(R) 8 Series Chipset Drivers**. Click **Intel(R) PRO LAN Network Drivers**.



2. Click **Install Drivers and Software**.

4. When the Welcome screen appears, click **Next**.

5. Click **Next** to agree with the license agreement.

6. Click the checkbox for **Drivers** in the Setup Options screen to select it and click **Next** to continue.

7. The wizard is ready to begin installation. Click **Install** to begin the installation.

8. When InstallShield Wizard is complete, click **Finish**.

## **Intel® Management Engine Interface**

---

Follow the steps below to install the Intel Management Engine.

1. Insert the DVD that comes with the board. Click *Intel* and then *Intel(R) 8 Series Chipset Drivers* and then *Intel(R) ME 9.0 Drivers*.



2. When the Welcome screen to the InstallShield Wizard for Intel® Management Engine Components, click the checkbox for **Install Intel® Control Center** & click *Next*.
3. Click *Yes* to to agree with the license agreement.
4. When the Setup Progress screen appears, click *Next*. Then, click *Finish* when the setup progress has been successfully installed.

## Intel® USB 3.0 Drivers

1. Insert the DVD that comes with the board. Click *Intel* and then *Intel(R) 8 Series Chipset Drivers*. Click *Intel(R) USB 3.0 Drivers*.



2. When the Welcome screen to the InstallShield Wizard for Intel® USB 3.0 eXtensible Host Controller Driver, click *Next*.

3. Click *Yes* to agree with the license agreement and continue the installation.

4. On the Readme File Information screen, click *Next* to continue the installation of the Intel® USB 3.0 eXtensible Host Controller Driver.

5. When the Setup Progress screen appears, click *Next*. Setup complete. Click *Finish* to restart the computer and for changes to take effect.

This page is intentionally set blank.



## Appendix

### A. I/O Port Address Map

Each peripheral device in the system is assigned a set of I/O port addresses which also becomes the identity of the device. The following table lists the I/O port addresses used.

Address	Device Description
0000h-001Fh	Direct memory access controller
0000h-001Fh	PCI bus
0040h-0043h	System timer
0050h-0053h	System timer
0070h-0077h	System CMOS/real time clock
0081h-0091h	Direct memory access controller
0093h-009Fh	Direct memory access controller
00C0h-00DFh	Direct memory access controller
00F0h-00F0h	Numeric data processor
02F8h-02FFh	Communications Port (COM2)
03B0h-03BBh	Intel(R) HD Graphics 4600
03C0h-03DFh	Intel(R) HD Graphics 4600
03F8h-03FFh	Communications Port (COM1)
0D00h-FFFFh	PCI bus
E000h-EFFFh	Intel(R) 8 Series/C220 Series PCI Express Root Port #7 - 8C1C
F000h-F03Fh	Intel(R) HD Graphics 4600
F040h-F05Fh	Intel(R) 8 Series/C220 Series SMBus Controller - 8C22
F060h-F07Fh	Intel(R) 8 Series/C220 Series SATA AHCI Controller - 8C02
F0A0h-F0A3h	Intel(R) 8 Series/C220 Series SATA AHCI Controller - 8C02
F0B0h-F0B7h	Intel(R) 8 Series/C220 Series SATA AHCI Controller - 8C02
F0C0h-F0C3h	Intel(R) 8 Series/C220 Series SATA AHCI Controller - 8C02
F0D0h-F0D7h	Intel(R) 8 Series/C220 Series SATA AHCI Controller - 8C02
F0E0h-F0E7h	Intel(R) Active Management Technology - SOL (COM3)

## B. Interrupt Request Lines (IRQ)

Peripheral devices use interrupt request lines to notify CPU for the service required. The following table shows the IRQ used by the devices on board.

<b>Level</b>	<b>Function</b>
IRQ0	System Timer
IRQ3	Serial Port #2
IRQ4	Serial Port #1
IRQ 10	Intel(R) 8 Series/C220 Series SMBus Controller - 8C22
IRQ 13	Numeric data processor
IRQ 16	High Definition Audio Controller
IRQ 16	Intel(R) 8 Series/C220 Series USB EHCI #2 - 8C2D
IRQ 16	Intel(R) Management Engine Interface
IRQ 19	Intel(R) 8 Series/C220 Series SATA AHCI Controller - 8C02
IRQ 19	Intel(R) Active Management Technology - SOL (COM3)
IRQ 22	High Definition Audio Controller
IRQ 23	Intel(R) 8 Series/C220 Series USB EHCI #1 - 8C26

## C. Digital I/O Sample Code

File of the NCT5523D.H

```
//-----  
// THIS CODE AND INFORMATION IS PROVIDED "AS IS" WITHOUT WARRANTY OF ANY  
// KIND, EITHER EXPRESSED OR IMPLIED, INCLUDING BUT NOT LIMITED TO THE  
// IMPLIED WARRANTIES OF MERCHANTABILITY AND/OR FITNESS FOR A PARTICULAR  
// PURPOSE.  
//-----  
#ifndef __NCT5523D_H  
#define __NCT5523D_H          1  
//-----  
#define  NCT5523D_INDEX_PORT      (NCT5523D_BASE)  
#define  NCT5523D_DATA_PORT      (NCT5523D_BASE+1)  
//-----  
#define  NCT5523D_REG_LD          0x07  
//-----  
#define  NCT5523D_UNLOCK          0x87  
#define  NCT5523D_LOCK           0xAA  
//-----  
unsigned int Init_NCT5523D(void);  
void Set_NCT5523D_LD( unsigned char);  
void Set_NCT5523D_Reg( unsigned char, unsigned char);  
unsigned char Get_NCT5523D_Reg( unsigned char);  
//-----  
#endif//__NCT5523D_H
```

File of the MAIN.CPP

```
//-----  
// THIS CODE AND INFORMATION IS PROVIDED "AS IS" WITHOUT WARRANTY OF ANY  
// KIND, EITHER EXPRESSED OR IMPLIED, INCLUDING BUT NOT LIMITED TO THE  
// IMPLIED WARRANTIES OF MERCHANTABILITY AND/OR FITNESS FOR A PARTICULAR  
// PURPOSE.  
//-----  
#include <dos.h>  
#include <conio.h>  
#include <stdio.h>  
#include <stdlib.h>  
#include "NCT5523D.H"  
//-----  
int main (void);  
  
void Dio5Initial(void);  
void Dio5SetOutput(unsigned char);  
unsigned char Dio5GetInput(void);  
void Dio5SetDirection(unsigned char);  
unsigned char Dio5GetDirection(void);  
//-----  
int main (void)  
{  
    char SIO;  
  
    SIO = Init_NCT5523D();  
    if (SIO == 0)  
    {  
        printf("Can not detect Nuvoton NCT5523D, program abort.\n");  
        return(1);  
    }  
  
    Dio5Initial();  
  
    //for GPIO20..27  
    Dio5SetDirection(0x0F); //GP20..23 = input, GP24..27=output  
    printf("Current DIO direction = 0x%X\n", Dio5GetDirection());  
  
    printf("Current DIO status = 0x%X\n", Dio5GetInput());  
  
    printf("Set DIO output to high\n");  
    Dio5SetOutput(0x0F);  
  
    printf("Set DIO output to low\n");  
    Dio5SetOutput(0x00);  
  
    return 0;  
}  
//-----
```

```
void Dio5Initial(void)
{
    unsigned char ucBuf;

    ucBuf = Get_NCT5523D_Reg(0x1C);
    ucBuf &= ~0x02;
    Set_NCT5523D_Reg(0x1C, ucBuf);

    Set_NCT5523D_LD(0x07); //switch to logic device 7
    //enable the GP2 group
    ucBuf = Get_NCT5523D_Reg(0x30);
    ucBuf |= 0x04;
    Set_NCT5523D_Reg(0x30, ucBuf);
}
//-----
void Dio5SetOutput(unsigned char NewData)
{
    Set_NCT5523D_LD(0x07); //switch to logic device 7
    Set_NCT5523D_Reg(0xE1, NewData);
}
//-----
unsigned char Dio5GetInput(void)
{
    unsigned char result;

    Set_NCT5523D_LD(0x07); //switch to logic device 7
    result = Get_NCT5523D_Reg(0xE1);
    return (result);
}
//-----
void Dio5SetDirection(unsigned char NewData)
{
    //NewData : 1 for input, 0 for output
    Set_NCT5523D_LD(0x07); //switch to logic device 7
    Set_NCT5523D_Reg(0xE8, NewData);
}
//-----
unsigned char Dio5GetDirection(void)
{
    unsigned char result;

    Set_NCT5523D_LD(0x07); //switch to logic device 7
    result = Get_NCT5523D_Reg(0xE8);
    return (result);
}
//-----
```

## APPENDIX

---

File of the NCT5523D.CPP

```
//-----  
// THIS CODE AND INFORMATION IS PROVIDED "AS IS" WITHOUT WARRANTY OF ANY  
// KIND, EITHER EXPRESSED OR IMPLIED, INCLUDING BUT NOT LIMITED TO THE  
// IMPLIED WARRANTIES OF MERCHANTABILITY AND/OR FITNESS FOR A PARTICULAR  
// PURPOSE.  
//-----  
#include "NCT5523D.H"  
#include <dos.h>  
//-----  
unsigned int NCT5523D_BASE;  
void Unlock_NCT5523D (void);  
void Lock_NCT5523D (void);  
//-----  
unsigned int Init_NCT5523D(void)  
{  
    unsigned int result;  
    unsigned char ucDid;  
  
    NCT5523D_BASE = 0x4E;  
    result = NCT5523D_BASE;  
  
    ucDid = Get_NCT5523D_Reg(0x20);  
    if (ucDid == 0xC4) //NCT5523D??  
    { goto Init_Finish; }  
  
    NCT5523D_BASE = 0x2E;  
    result = NCT5523D_BASE;  
  
    ucDid = Get_NCT5523D_Reg(0x20);  
    if (ucDid == 0xC4) //NCT5523D??  
    { goto Init_Finish; }  
  
    NCT5523D_BASE = 0x00;  
    result = NCT5523D_BASE;  
  
Init_Finish:  
    return (result);  
}  
//-----  
void Unlock_NCT5523D (void)  
{  
    outportb(NCT5523D_INDEX_PORT, NCT5523D_UNLOCK);  
    outportb(NCT5523D_INDEX_PORT, NCT5523D_UNLOCK);  
}  
//-----  
void Lock_NCT5523D (void)  
{  
    outportb(NCT5523D_INDEX_PORT, NCT5523D_LOCK);  
}  
//-----
```

```
void Set_NCT5523D_LD( unsigned char LD)
{
    Unlock_NCT5523D();
    outputb(NCT5523D_INDEX_PORT, NCT5523D_REG_LD);
    outputb(NCT5523D_DATA_PORT, LD);
    Lock_NCT5523D();
}
//-----
void Set_NCT5523D_Reg( unsigned char REG, unsigned char DATA)
{
    Unlock_NCT5523D();
    outputb(NCT5523D_INDEX_PORT, REG);
    outputb(NCT5523D_DATA_PORT, DATA);
    Lock_NCT5523D();
}
//-----
unsigned char Get_NCT5523D_Reg(unsigned char REG)
{
    unsigned char Result;
    Unlock_NCT5523D();
    outputb(NCT5523D_INDEX_PORT, REG);
    Result = inputb(NCT5523D_DATA_PORT);
    Lock_NCT5523D();
    return Result;
}
//-----
```

## D. Watchdog Timer Configuration

The WDT is used to generate a variety of output signals after a user programmable count. The WDT is suitable for use in the prevention of system lock-up, such as when software becomes trapped in a deadlock. Under these sorts of circumstances, the timer will count to zero and the selected outputs will be driven. Under normal circumstance, the user will restart the WDT at regular intervals before the timer counts to zero.

### SAMPLE CODE:

```
File of the NCT5523D.H
//-----
//
// THIS CODE AND INFORMATION IS PROVIDED "AS IS" WITHOUT WARRANTY OF ANY
// KIND, EITHER EXPRESSED OR IMPLIED, INCLUDING BUT NOT LIMITED TO THE
// IMPLIED WARRANTIES OF MERCHANTABILITY AND/OR FITNESS FOR A PARTICULAR
// PURPOSE.
//
//-----
#ifndef __NCT5523D_H
#define __NCT5523D_H            1
//-----
#define NCT5523D_INDEX_PORT    (NCT5523D_BASE)
#define NCT5523D_DATA_PORT    (NCT5523D_BASE+1)
//-----
#define NCT5523D_REG_LD        0x07
//-----
#define NCT5523D_UNLOCK        0x87
#define NCT5523D_LOCK          0xAA
//-----
unsigned int Init_NCT5523D(void);
void Set_NCT5523D_LD( unsigned char);
void Set_NCT5523D_Reg( unsigned char, unsigned char);
unsigned char Get_NCT5523D_Reg( unsigned char);
//-----
#endif// __NCT5523D_H
```



File of the MAIN.CPP.

```
//-----  
//  
// THIS CODE AND INFORMATION IS PROVIDED "AS IS" WITHOUT WARRANTY OF ANY  
// KIND, EITHER EXPRESSED OR IMPLIED, INCLUDING BUT NOT LIMITED TO THE  
// IMPLIED WARRANTIES OF MERCHANTABILITY AND/OR FITNESS FOR A PARTICULAR  
// PURPOSE.  
//  
//-----  
#include <dos.h>  
#include <conio.h>  
#include <stdio.h>  
#include <stdlib.h>  
#include "NCT5523D.H"  
//-----  
int main (void);  
  
void WDTInitial(void);  
void WDTEnable(unsigned char);  
void WDTDisable(void);  
  
//-----  
int main (void)  
{  
    char SIO;  
  
    SIO = Init_NCT5523D();  
    if (SIO == 0)  
    {  
        printf("Can not detect Nuvoton NCT5523D, program abort.\n");  
        return(1);  
    }  
  
    WDTInitial();  
  
    WDTEnable(10);  
  
    WDTDisable();  
  
    return 0;  
}  
//-----  
void WDTInitial(void)  
{  
    unsigned char bBuf;  
    Set_NCT5523D_LD(0x08); //switch to logic device 8  
    bBuf = Get_NCT5523D_Reg(0x30);  
    bBuf &= (~0x01);  
    Set_NCT5523D_Reg(0x30, bBuf); //Enable WDTO  
}  
//-----
```

## APPENDIX

---

```
void WDTEnable(unsigned char NewInterval)
{
    unsigned char bBuf;

    Set_NCT5523D_LD(0x08);                //switch to logic device 8
    Set_NCT5523D_Reg(0x30, 0x01);        //enable timer

    bBuf = Get_NCT5523D_Reg(0xF0);
    bBuf &= (~0x08);
    Set_NCT5523D_Reg(0xF0, bBuf);        //count mode is second

    Set_NCT5523D_Reg(0xF1, NewInterval); //set timer
}
//-----
void WDTDisable(void)
{
    Set_NCT5523D_LD(0x08);                //switch to logic device 8
    Set_NCT5523D_Reg(0xF1, 0x00);        //clear watchdog timer
    Set_NCT5523D_Reg(0x30, 0x00);        //watchdog disabled
}
//-----
```

File of the NCT5523D.CPP

```
//-----
//
// THIS CODE AND INFORMATION IS PROVIDED "AS IS" WITHOUT WARRANTY OF ANY
// KIND, EITHER EXPRESSED OR IMPLIED, INCLUDING BUT NOT LIMITED TO THE
// IMPLIED WARRANTIES OF MERCHANTABILITY AND/OR FITNESS FOR A PARTICULAR
// PURPOSE.
//
//-----
#include "NCT5523D.H"
#include <dos.h>
//-----
unsigned int NCT5523D_BASE;
void Unlock_NCT5523D (void);
void Lock_NCT5523D (void);
//-----
unsigned int Init_NCT5523D(void)
{
    unsigned int result;
    unsigned char ucDid;

    NCT5523D_BASE = 0x4E;
    result = NCT5523D_BASE;

    ucDid = Get_NCT5523D_Reg(0x20);
    if (ucDid == 0xC4)                                //NCT5523D??
    {    goto Init_Finish;    }

    NCT5523D_BASE = 0x2E;
    result = NCT5523D_BASE;

    ucDid = Get_NCT5523D_Reg(0x20);
    if (ucDid == 0xC4)                                //NCT5523D??
    {    goto Init_Finish;    }

    NCT5523D_BASE = 0x00;
    result = NCT5523D_BASE;

Init_Finish:
    return (result);
}
//-----
void Unlock_NCT5523D (void)
{
    outportb(NCT5523D_INDEX_PORT, NCT5523D_UNLOCK);
    outportb(NCT5523D_INDEX_PORT, NCT5523D_UNLOCK);
}
//-----
void Lock_NCT5523D (void)
{
    outportb(NCT5523D_INDEX_PORT, NCT5523D_LOCK);
}
//-----
```

```
void Set_NCT5523D_LD( unsigned char LD)
{
    Unlock_NCT5523D();
    outportb(NCT5523D_INDEX_PORT, NCT5523D_REG_LD);
    outportb(NCT5523D_DATA_PORT, LD);
    Lock_NCT5523D();
}
//-----
void Set_NCT5523D_Reg( unsigned char REG, unsigned char DATA)
{
    Unlock_NCT5523D();
    outportb(NCT5523D_INDEX_PORT, REG);
    outportb(NCT5523D_DATA_PORT, DATA);
    Lock_NCT5523D();
}
//-----
unsigned char Get_NCT5523D_Reg(unsigned char REG)
{
    unsigned char Result;
    Unlock_NCT5523D();
    outportb(NCT5523D_INDEX_PORT, REG);
    Result = inportb(NCT5523D_DATA_PORT);
    Lock_NCT5523D();
    return Result;
}
//-----
```